



Hettich



4x

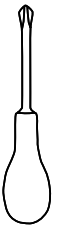

4x



1

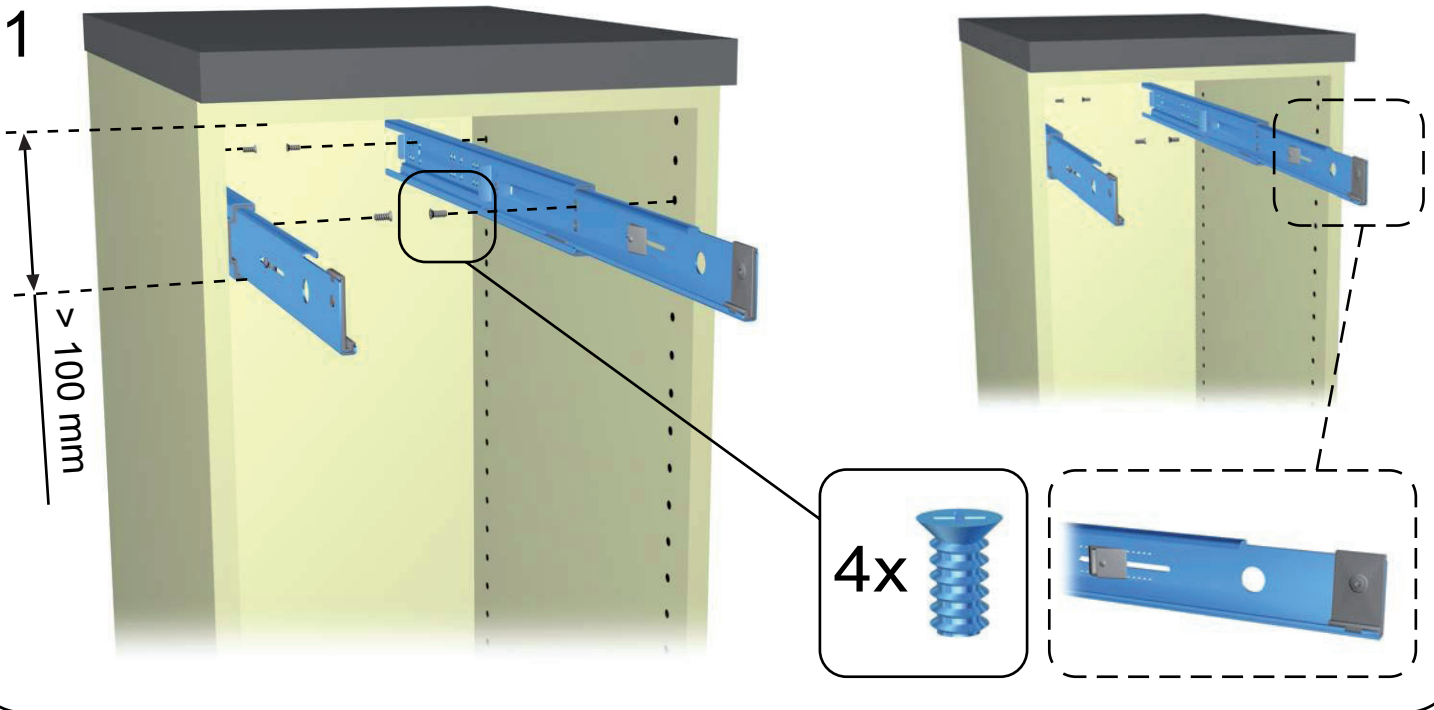

2

X (mm)

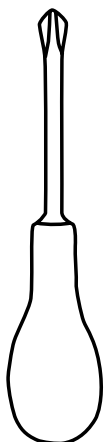
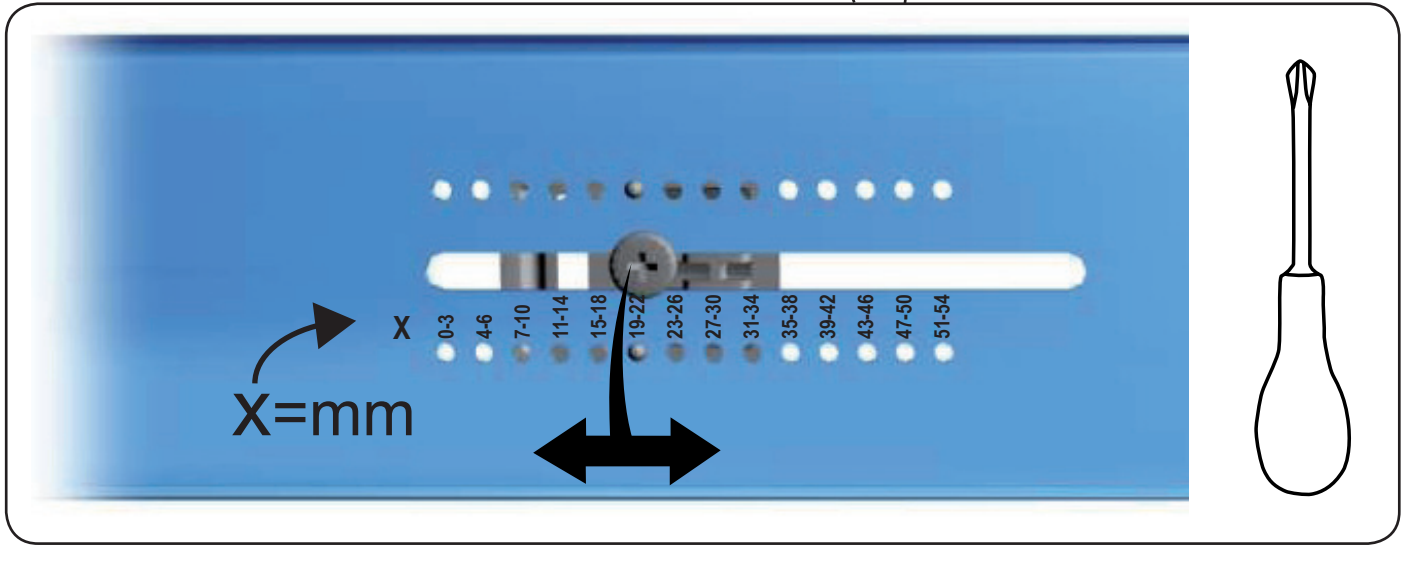
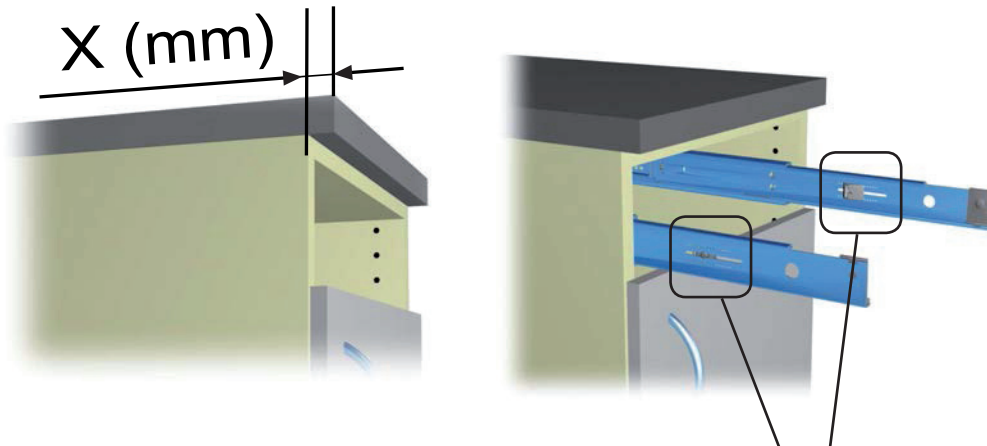

3

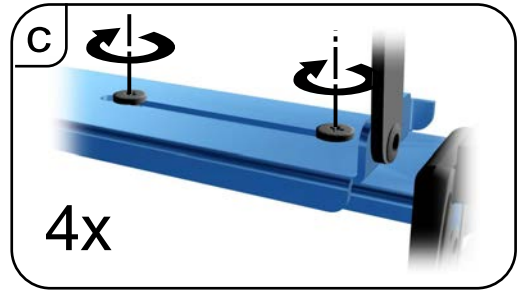
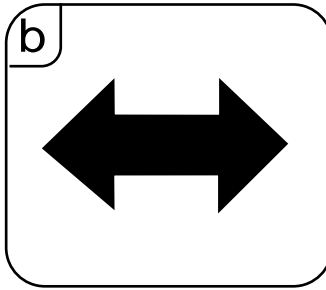
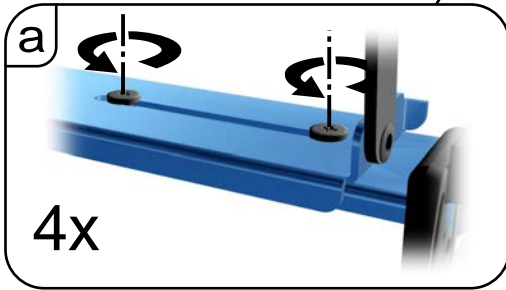
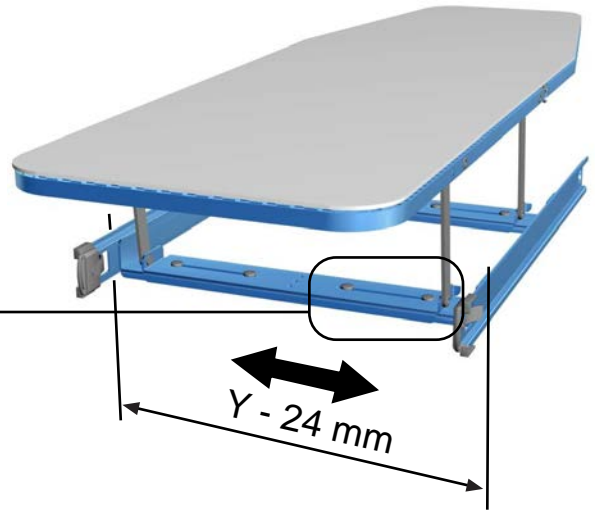
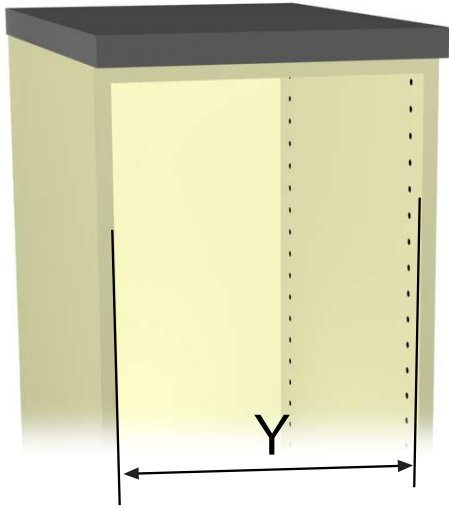

4

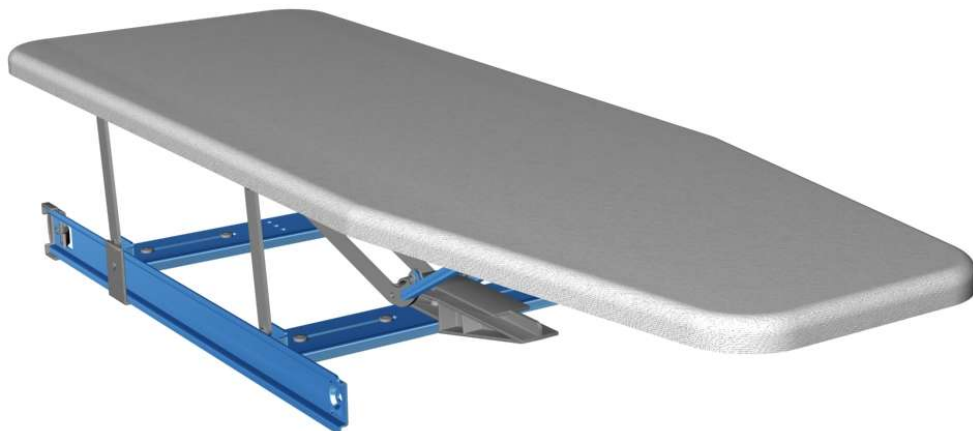
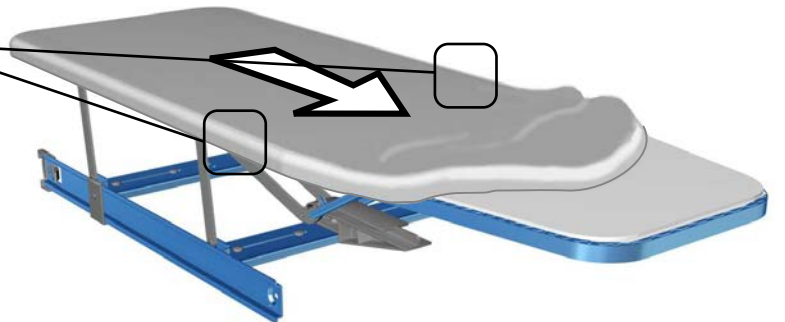
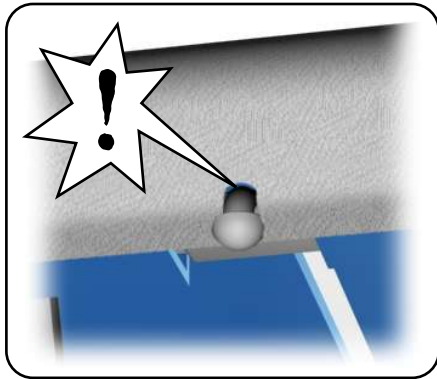

5

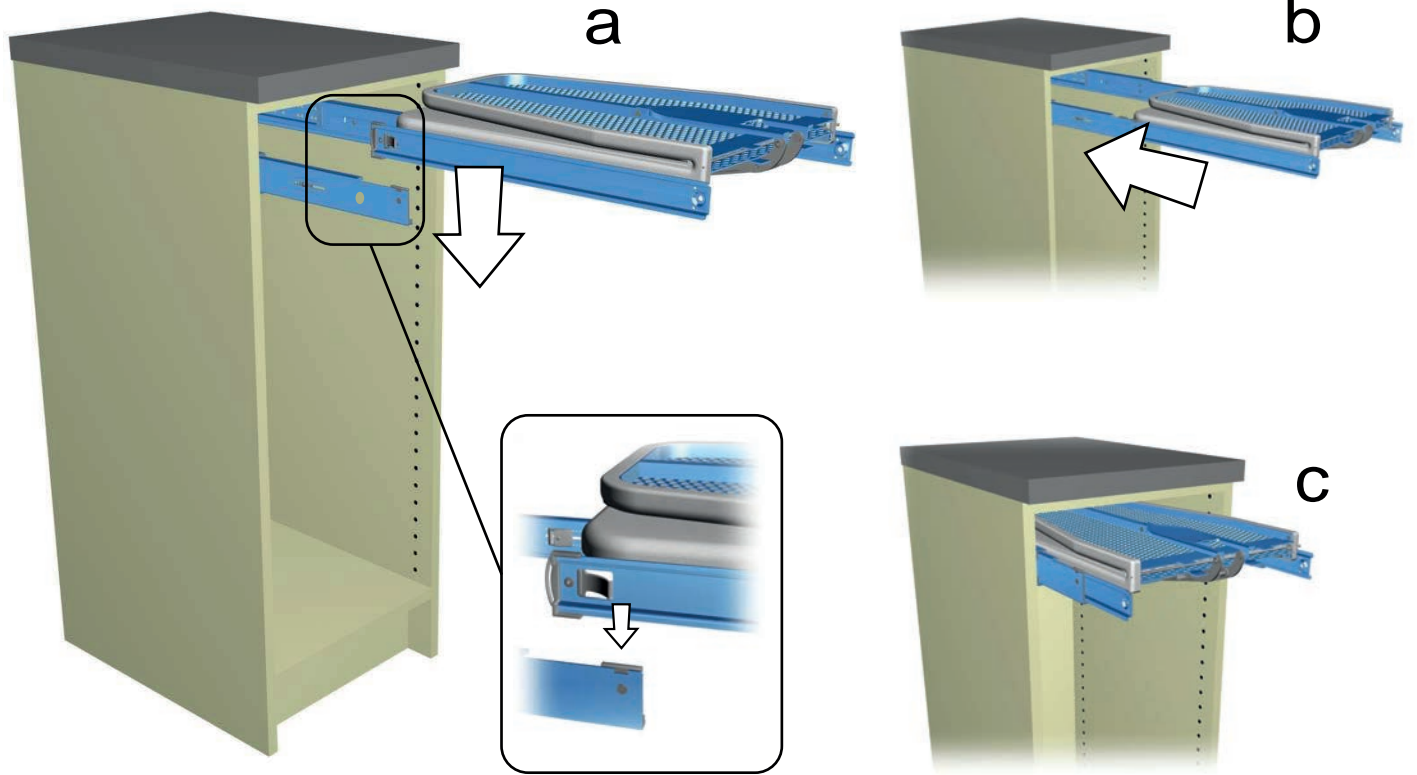

6

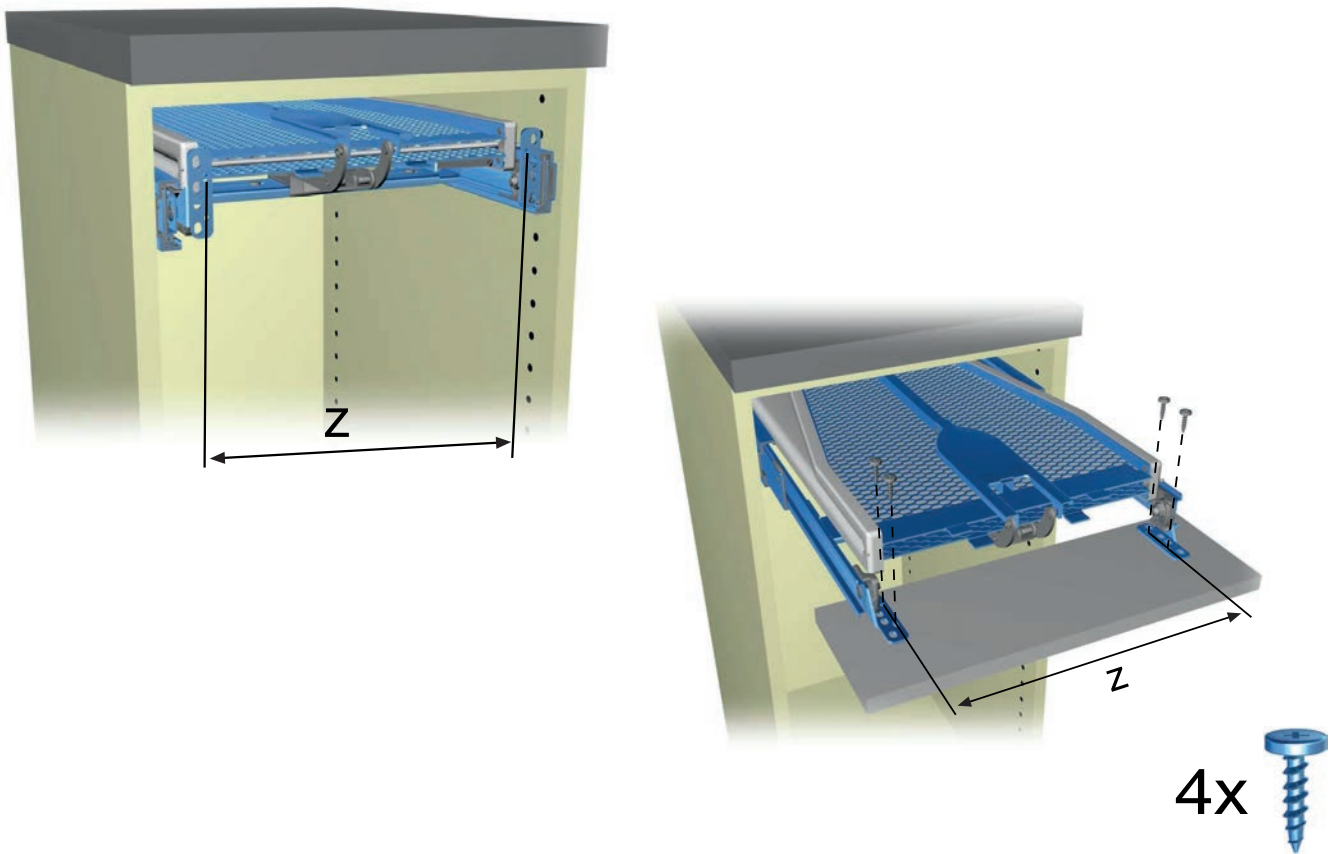

7



a



b

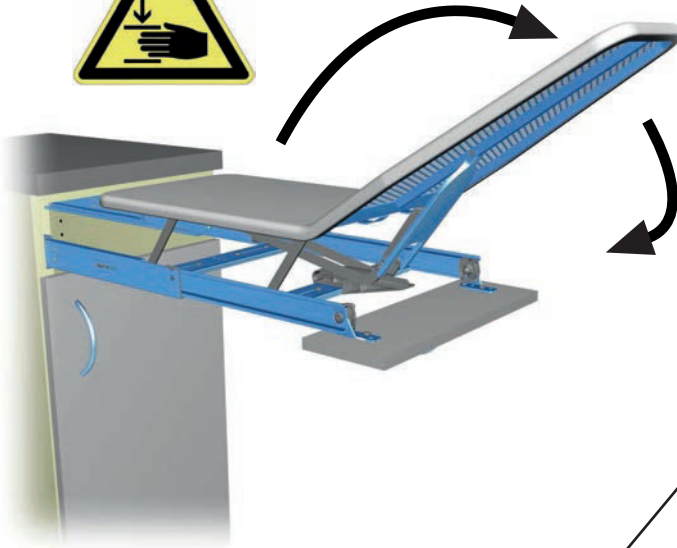

c

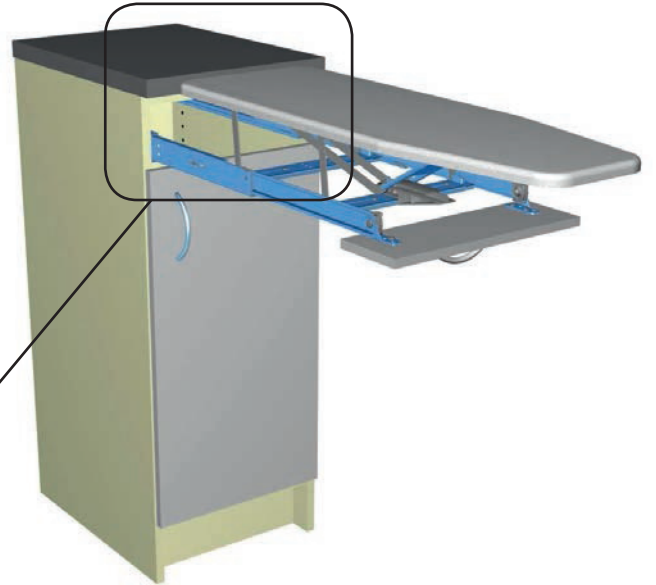

d

