

Drawings / Zeichnungen:
SysLine S

Technik für Möbel



Hettich

Article / Artikel	9 134 311
Doors / Türanzahl	2
Door thickness / Türdicke	max. 19 mm
Loading capacity / Belastbarkeit je Tür	15 kg
Bottom door guide / untere Türführung	Additional / zusätzlich STB 11 / 35

Further drawings with different side panel thickness (16 mm) and other versions can be found in the online catalogue in the category CAD data: 2D Sectional drawing (DXF).

Weitere Zeichnungen mit der Materialstärke 16 mm und weitere Montageversionen finden Sie im Onlinekatalog unter der Rubrik CAD Daten: Schnittzeichnungen 2D (DXF).

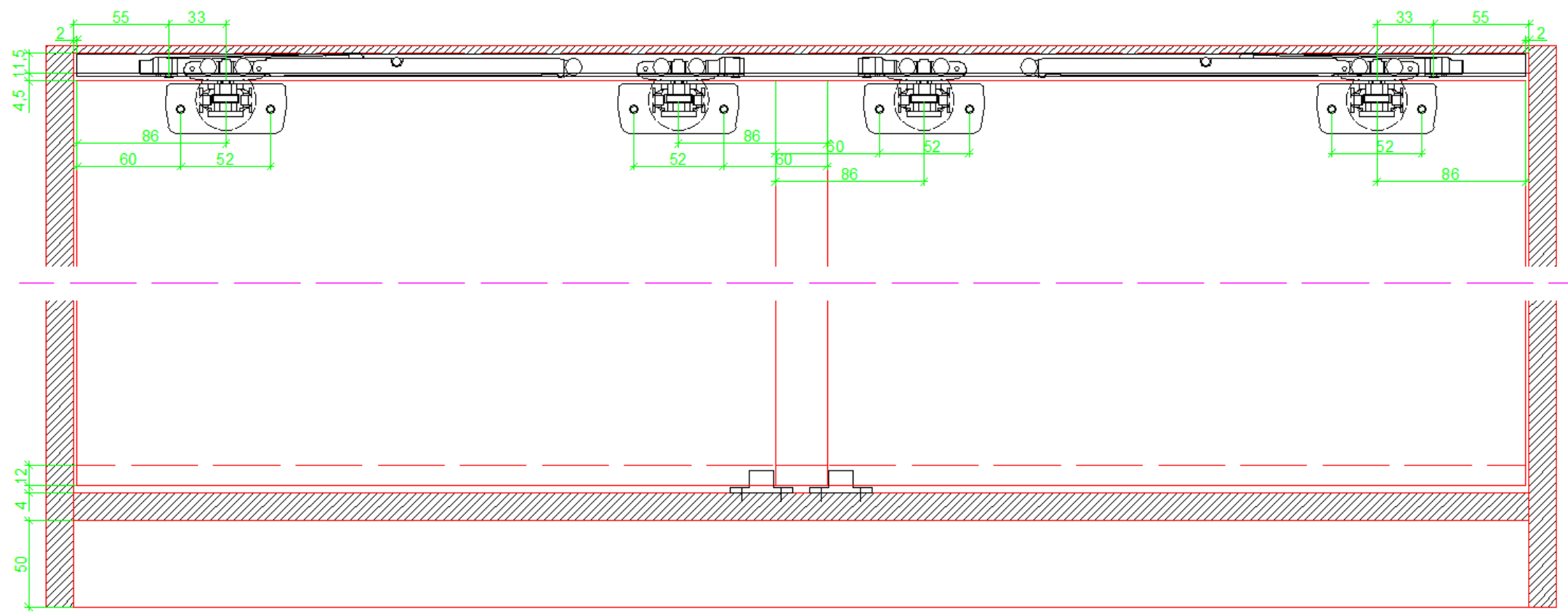
Frontview / Frontansicht (to glue in / zum Einkleben)



Frontview / Frontansicht (STB 11 & to glue in / zum Einkleben)

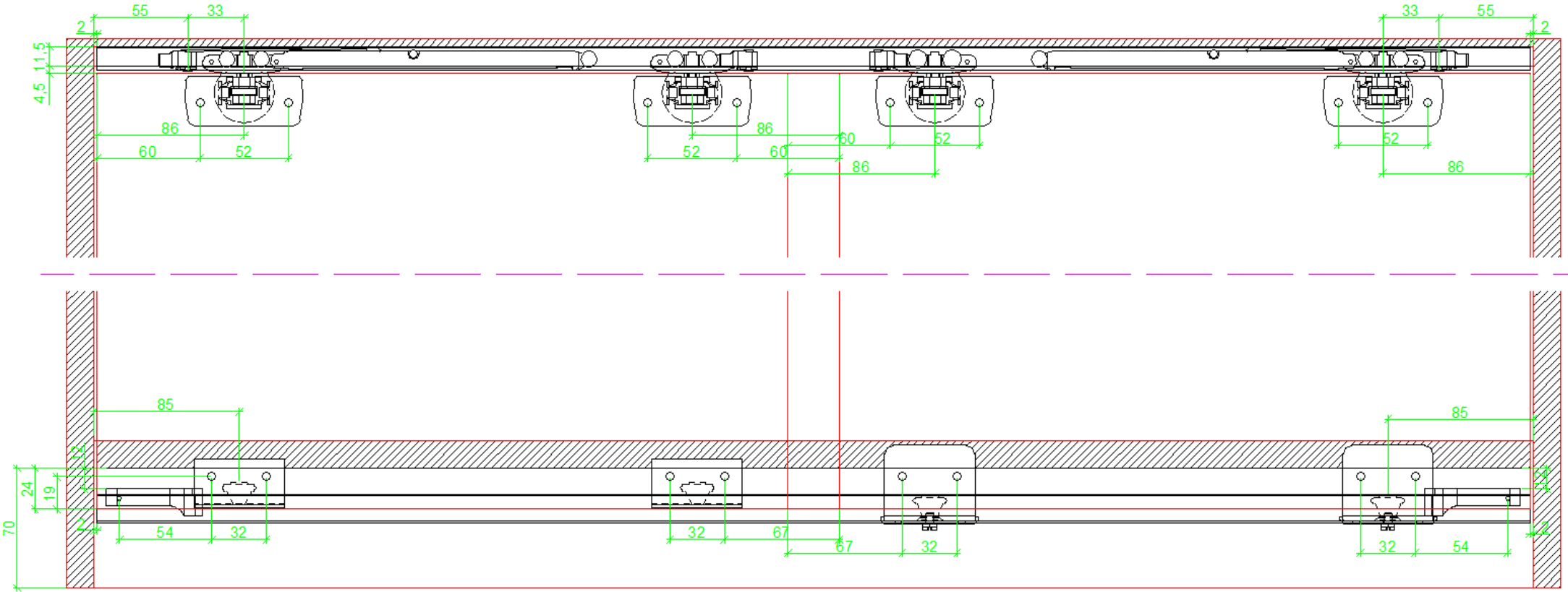

Frontview / Frontansicht (STB 35 & to glue in / zum Einkleben)

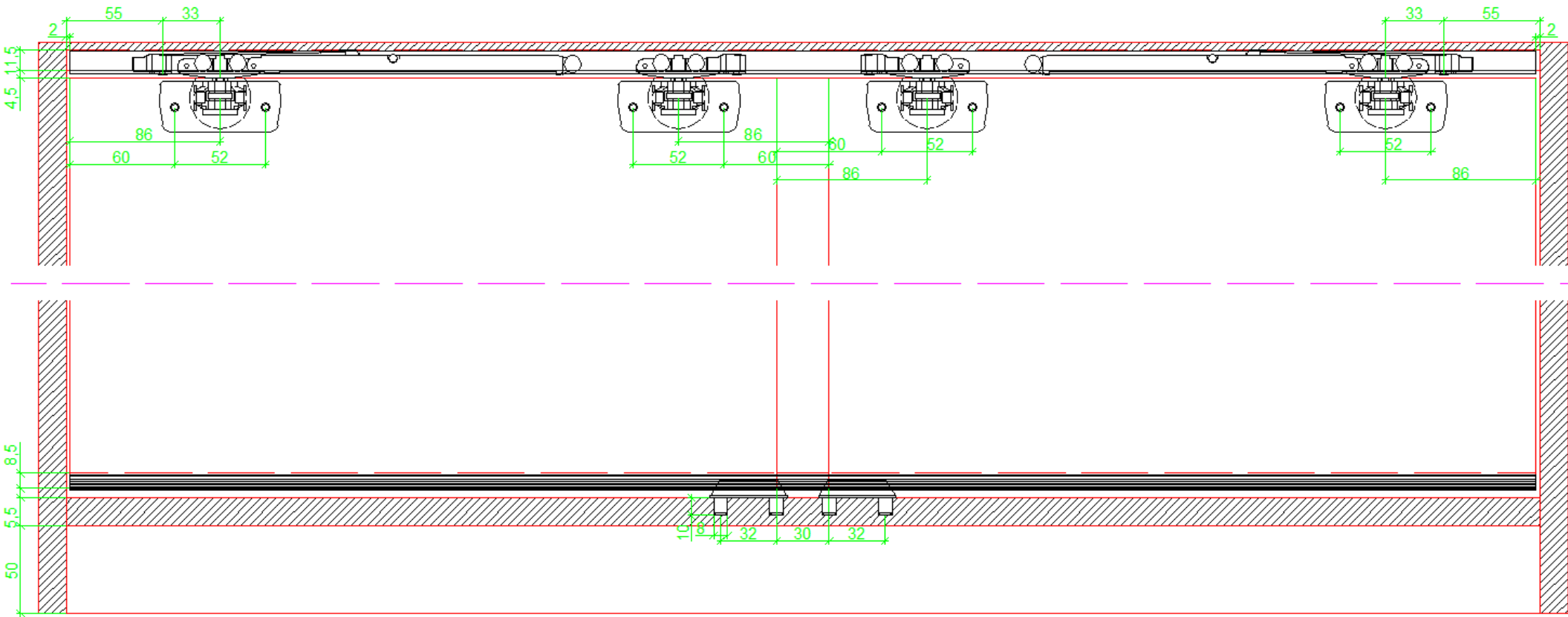

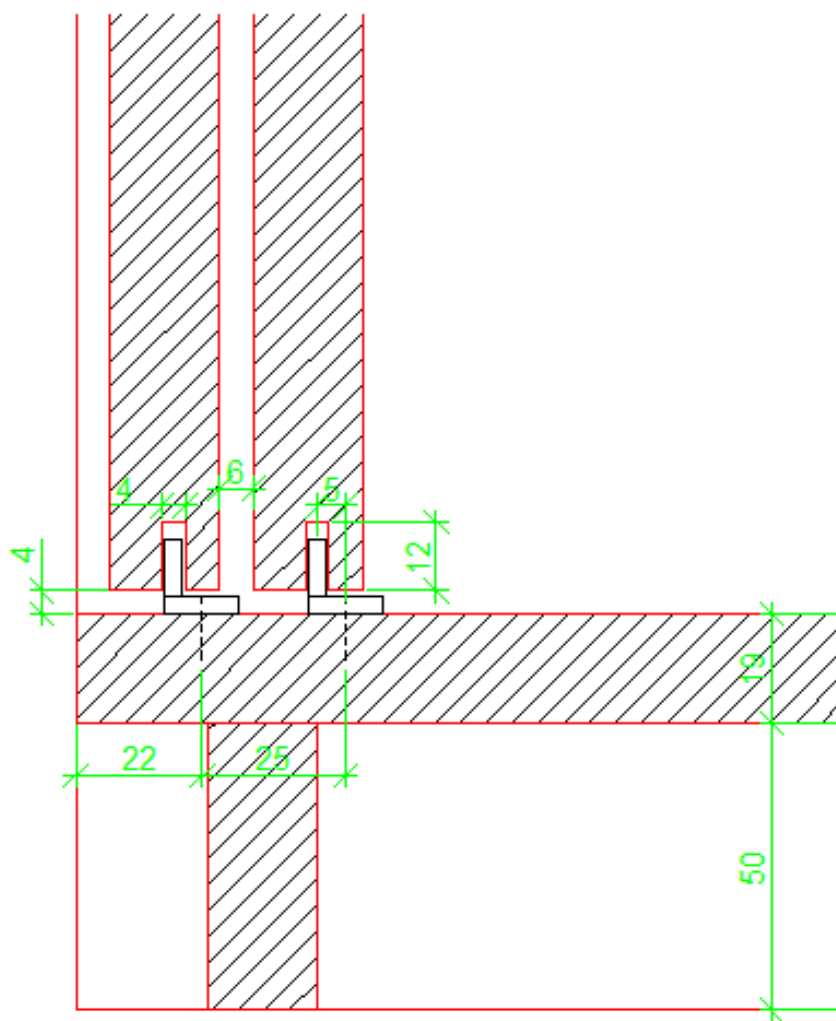
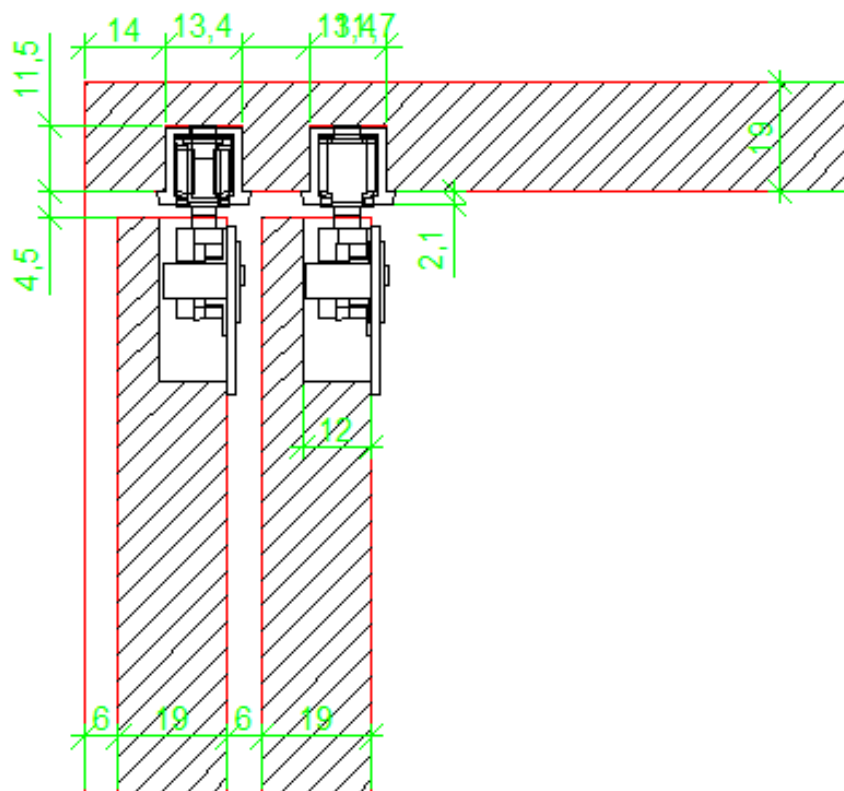

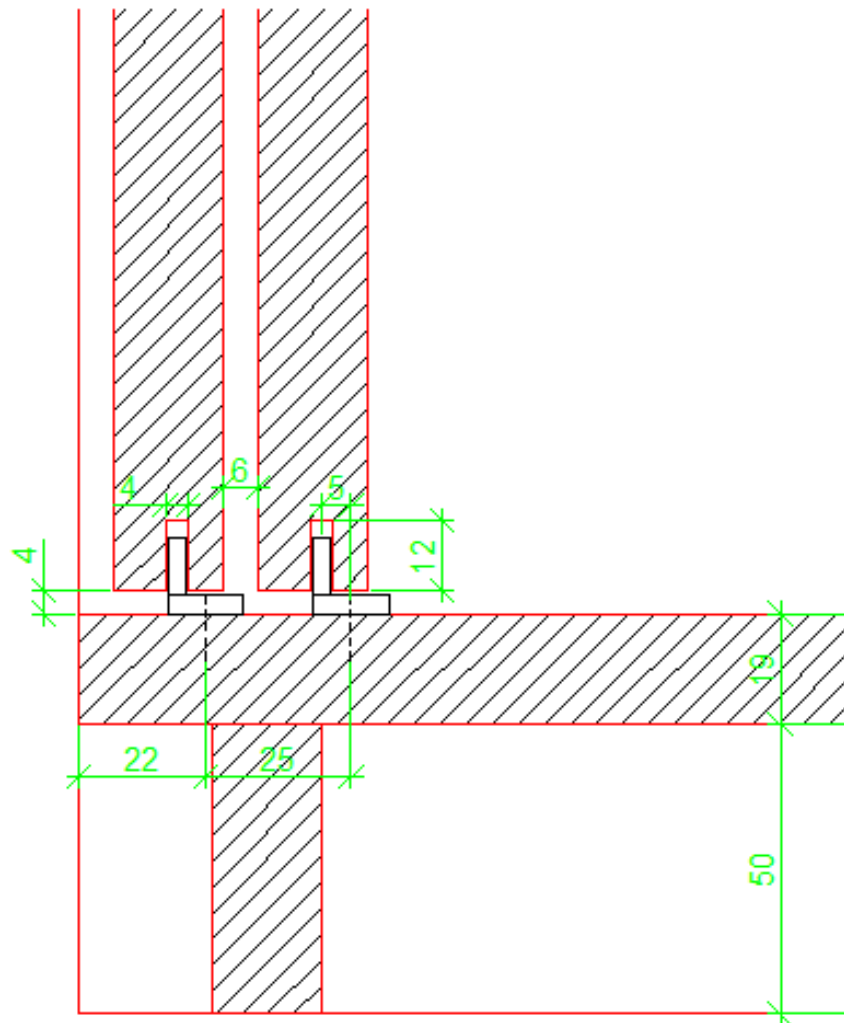
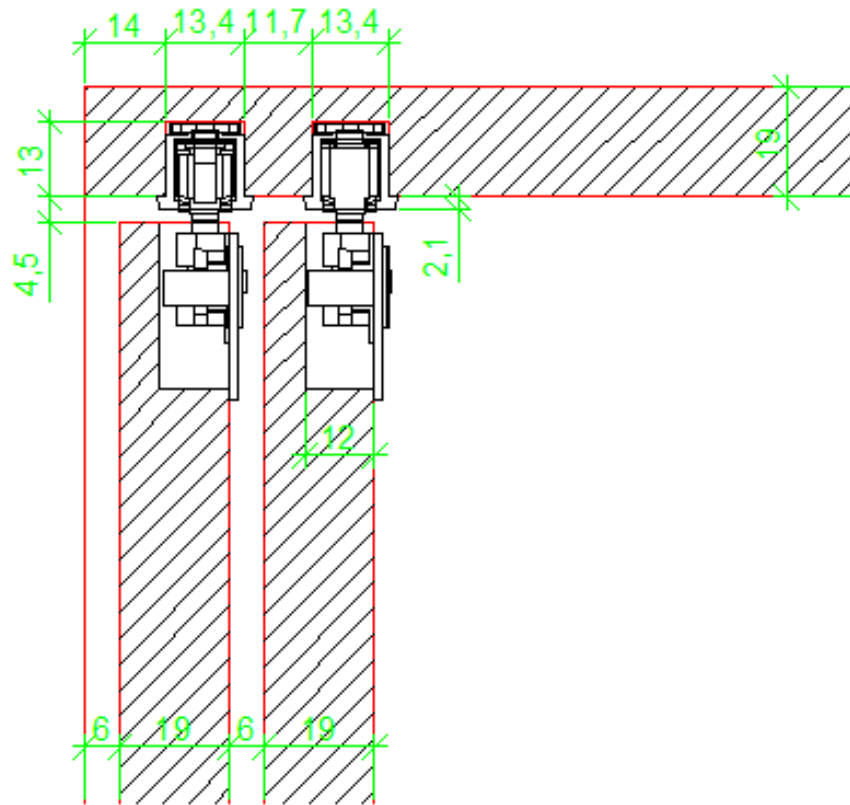

Sideview / Seitenansicht (STB 11 & to glue in / zum Einkleben / 19mm)

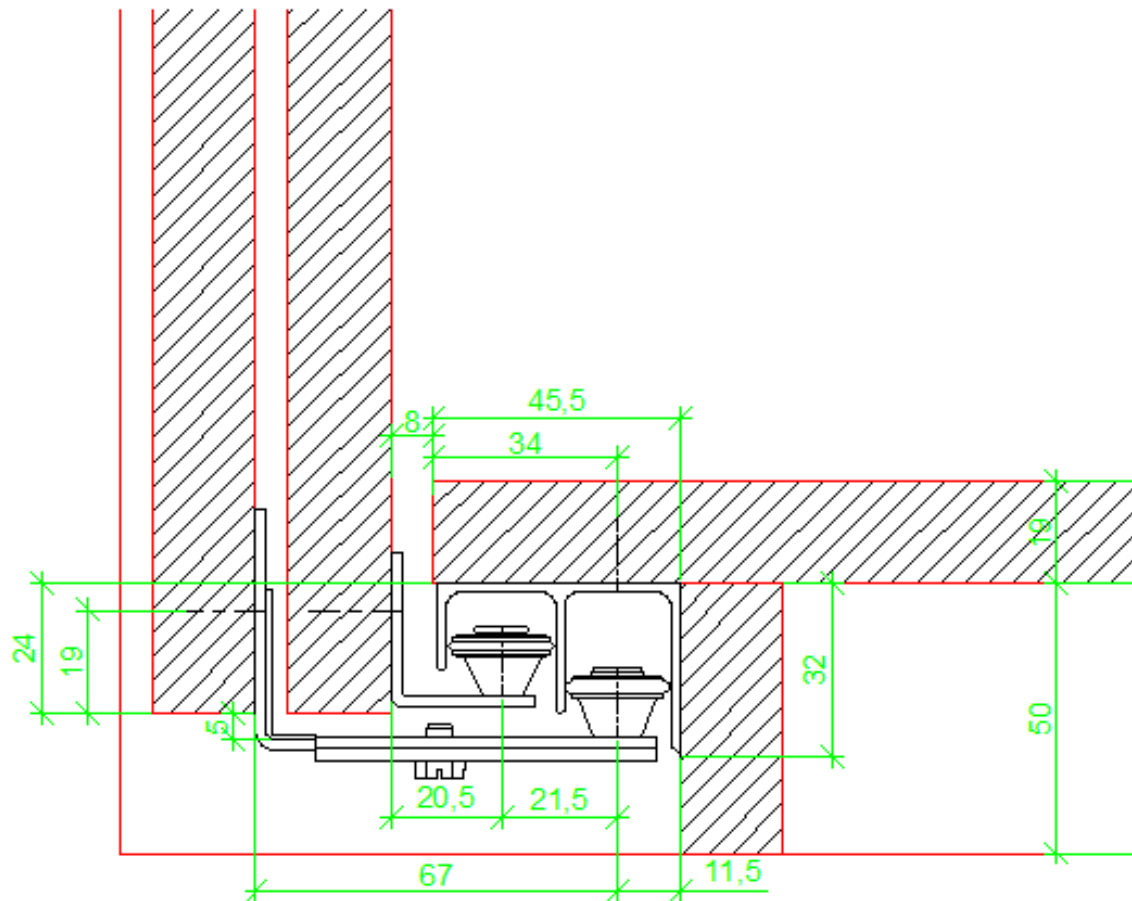
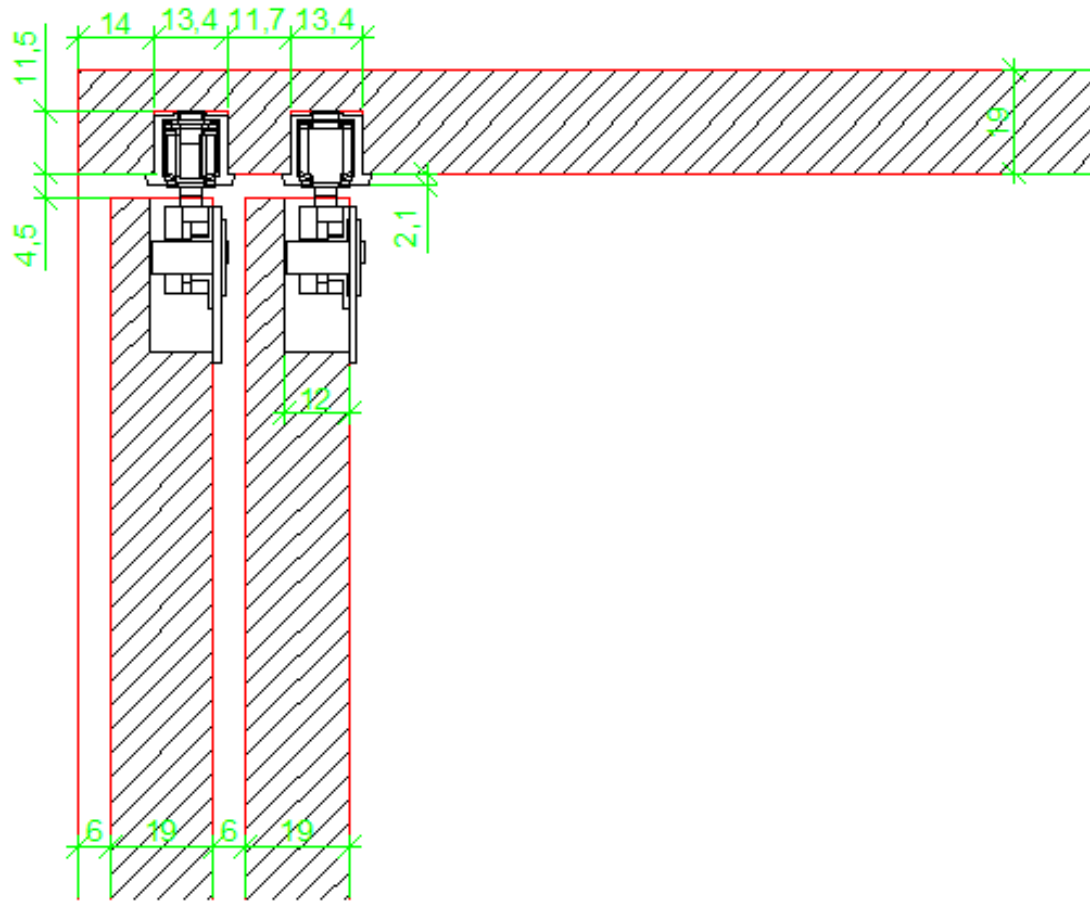

Sideview / Seitenansicht (STB 11 & with twist lock / mit Drehverriegelung / 19mm)

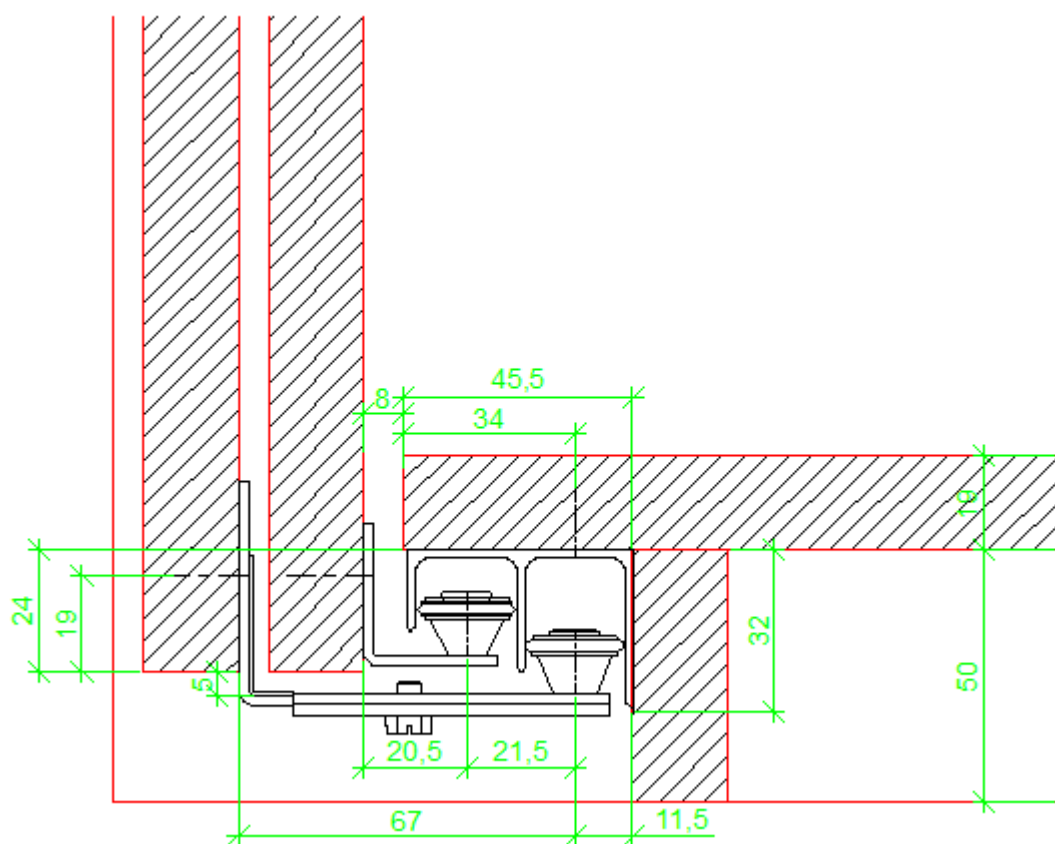
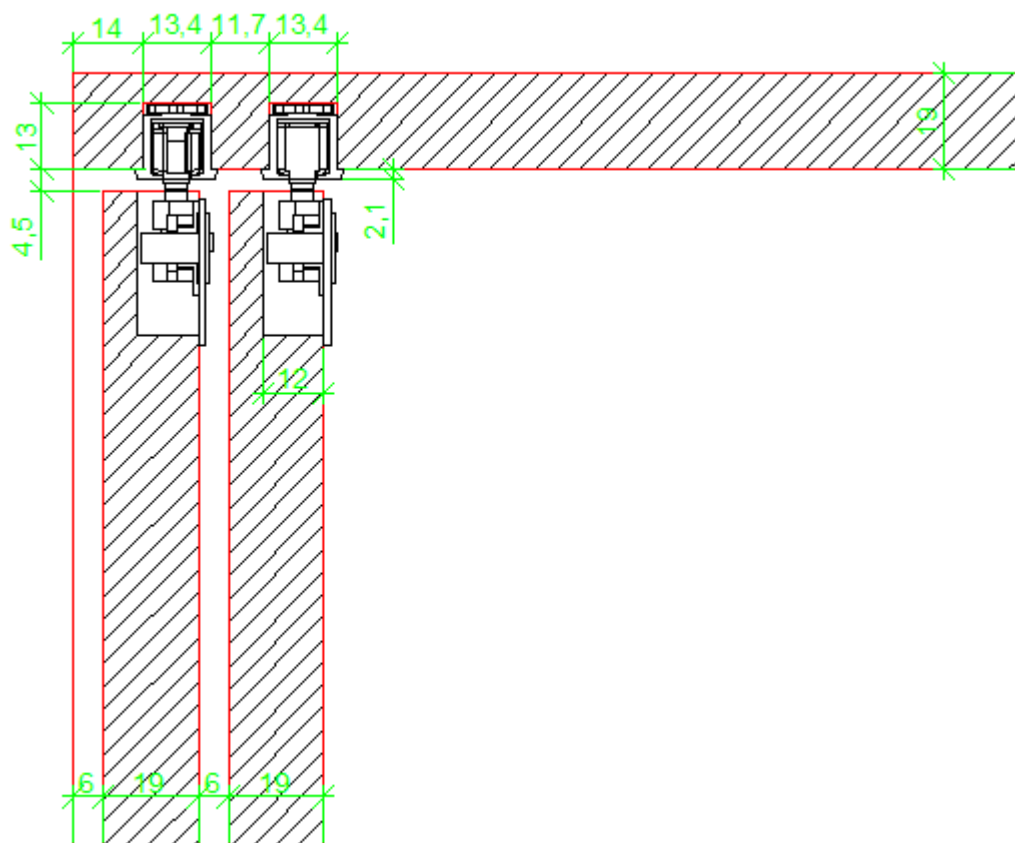

Sideview / Seitenansicht (STB 35 & with twist lock / mit Drehverriegelung / 19mm)

