



Drawings / Zeichnungen:  
ArciTech

Technik für Möbel

  
**Hettich**

Model / Ausführung	Pot and pan drawer / Frontauszug
Height / Höhe	250
Profile height / Zargenhöhe	126 mm
Nominal length / Nennlänge	270
Cabinet side panel thickness / Korpuseitendicke	16 / 18 / 19 mm

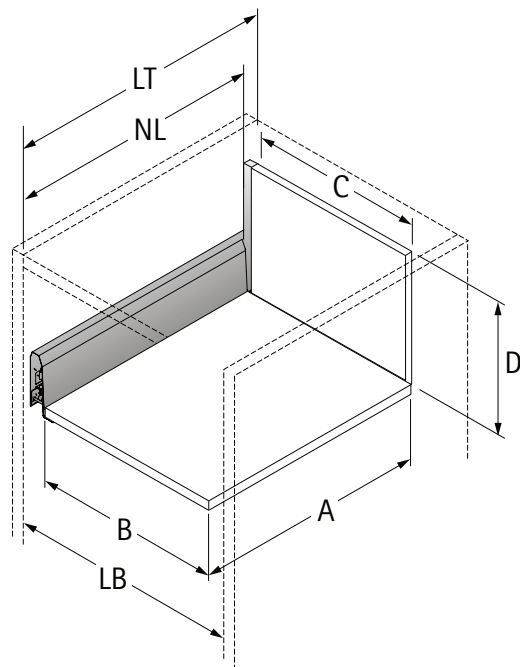

Measurement / Maß	Steel rear panel / Stahlrückwand	Wooden rear panel / Holzrückwand	Aluminium rear panel / Aluminiumrückwand
A	249	245,5	245,5
B	LB - 2x EB - 52	LB - 2x EB - 52	LB - 2x EB - 52
C	-	LB - 2x EB - 63,5	LB - 2x EB - 63,5
D	-	240	-

Frontview / Frontansicht 16 mm (Railing / Reling)

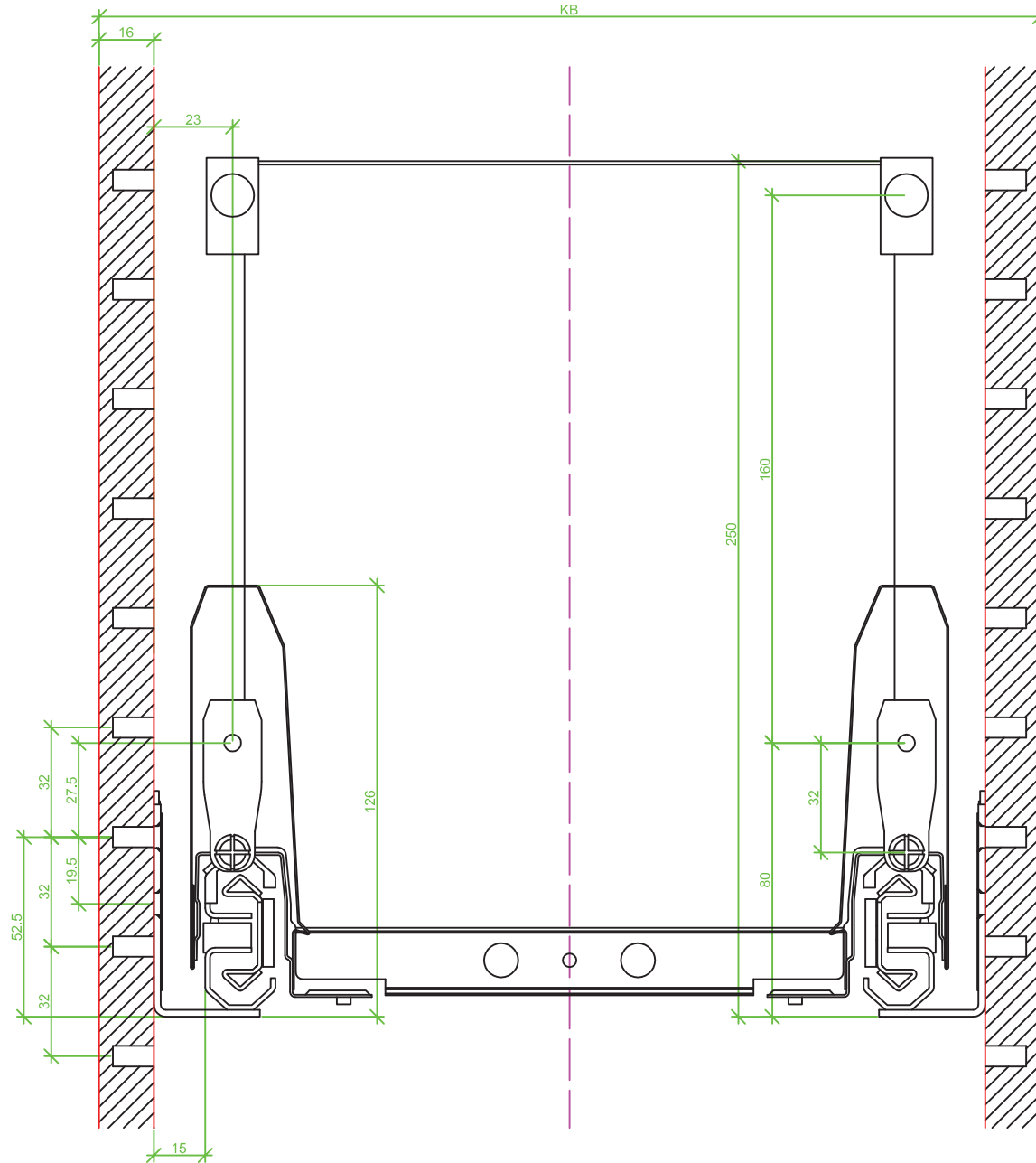

Frontview / Frontansicht 16 mm (DesignSide / TopSide)

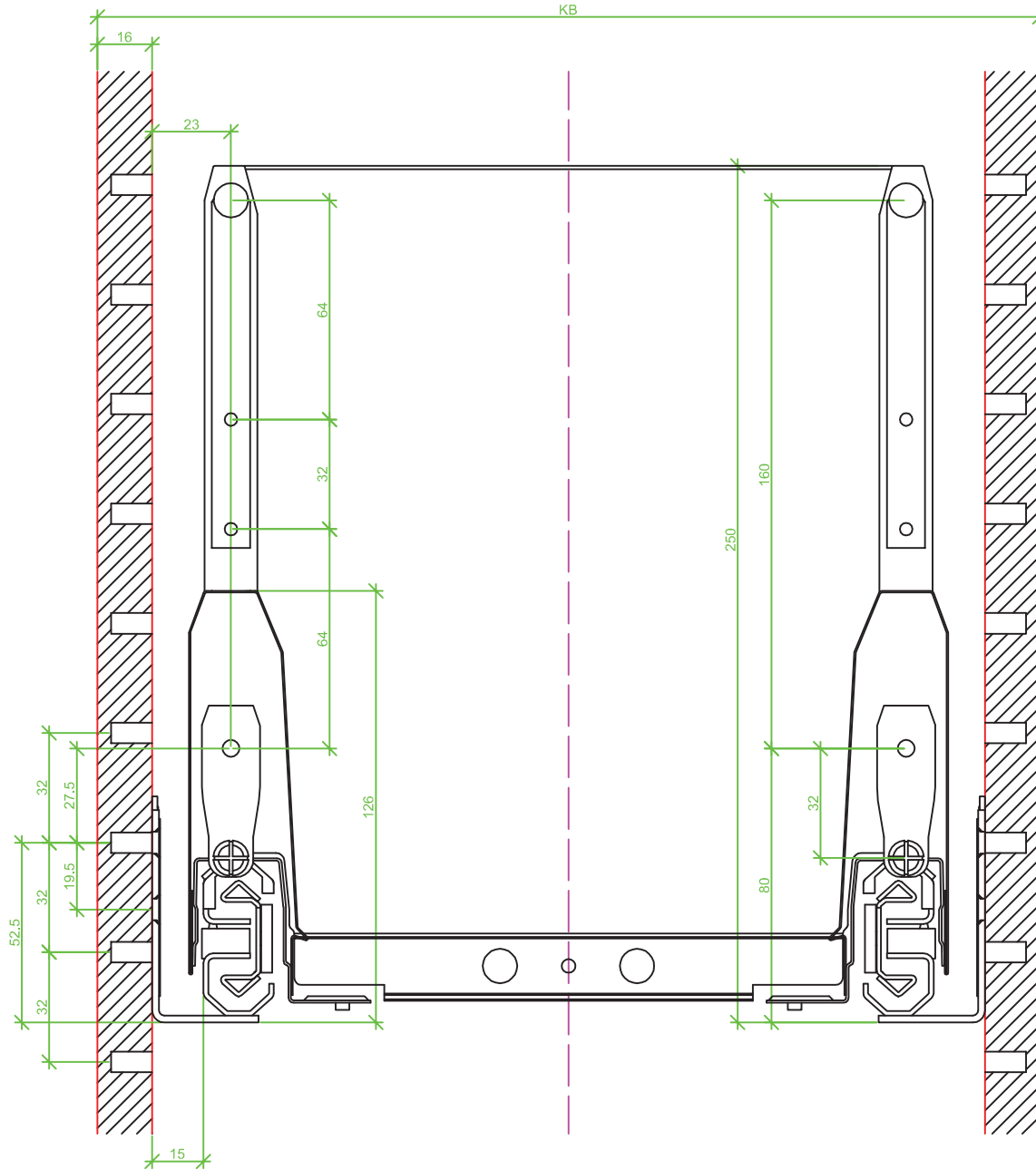

# Frontview / Frontansicht 18 mm (Railing / Reling)

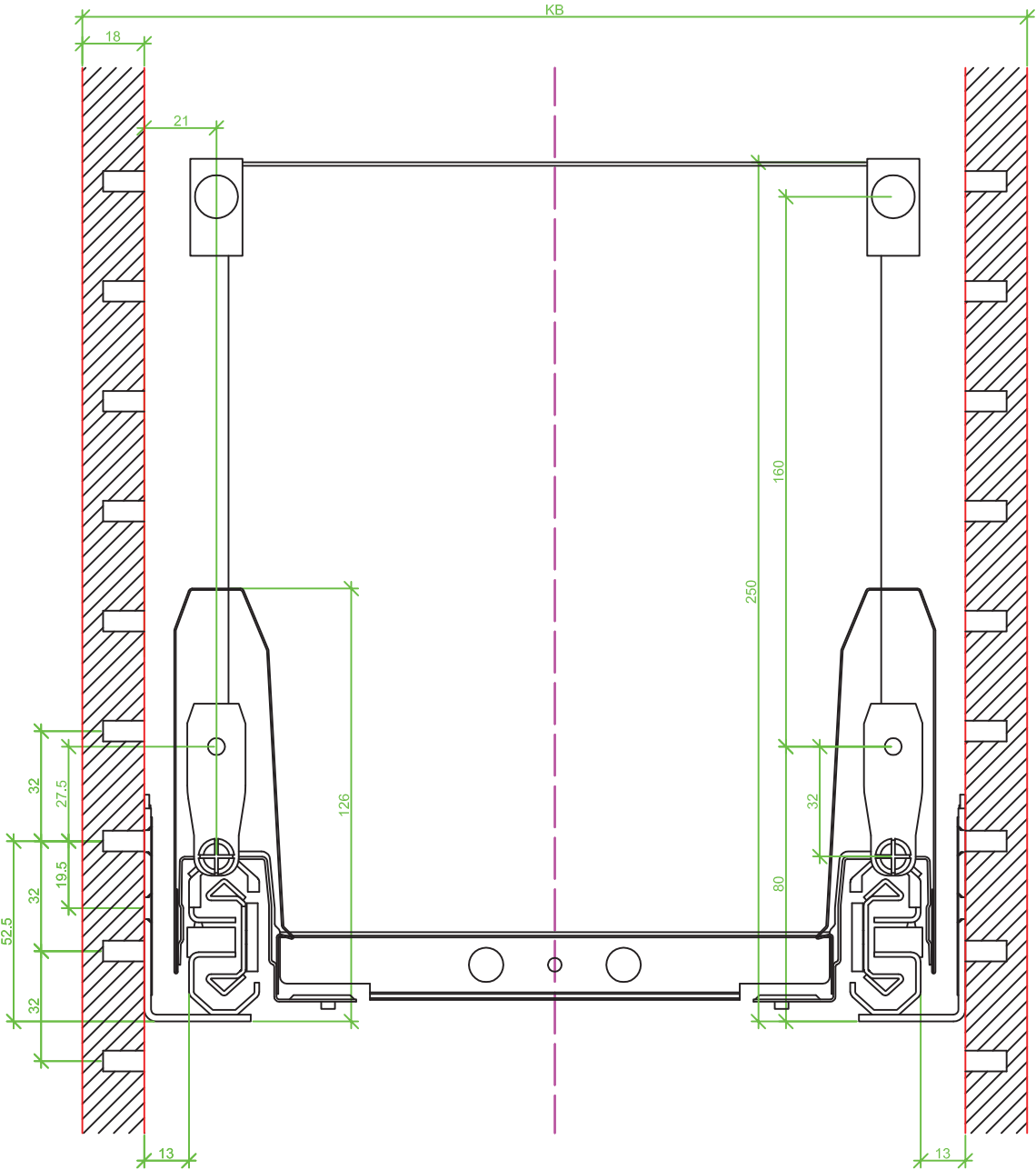

Frontview / Frontansicht 18 mm (DesignSide / TopSide)

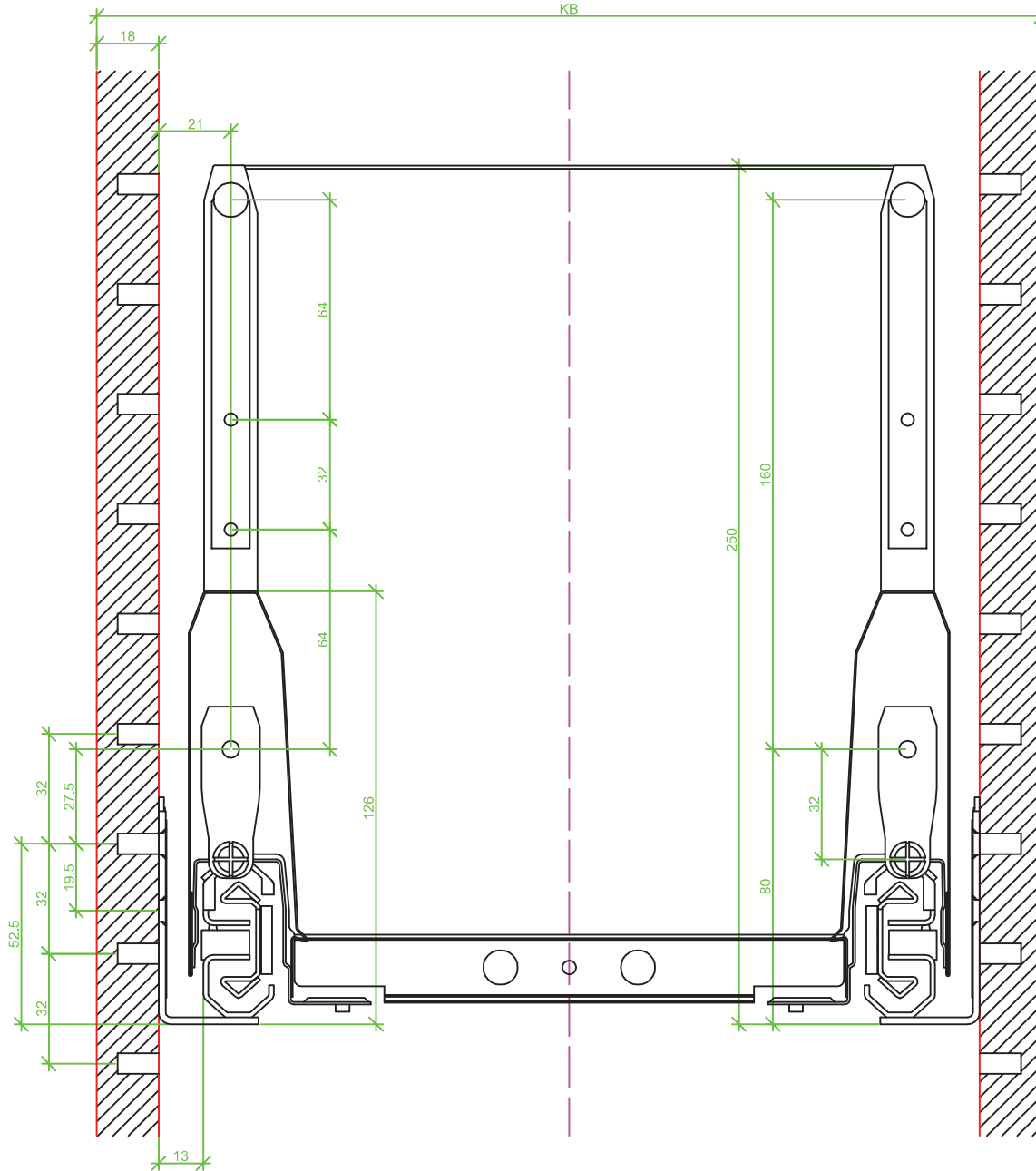

Frontview / Frontansicht 19 mm (Railing / Reling)

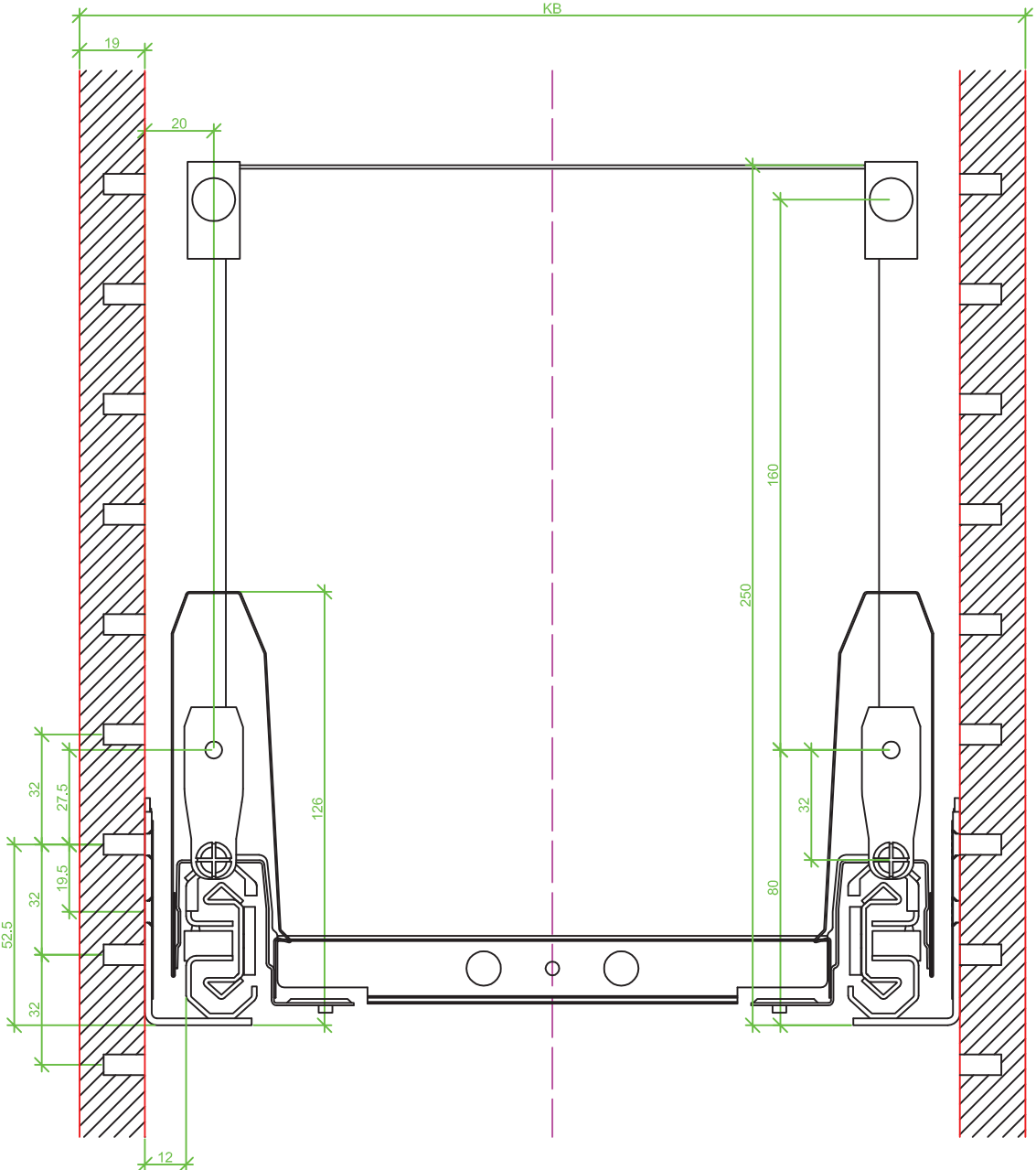

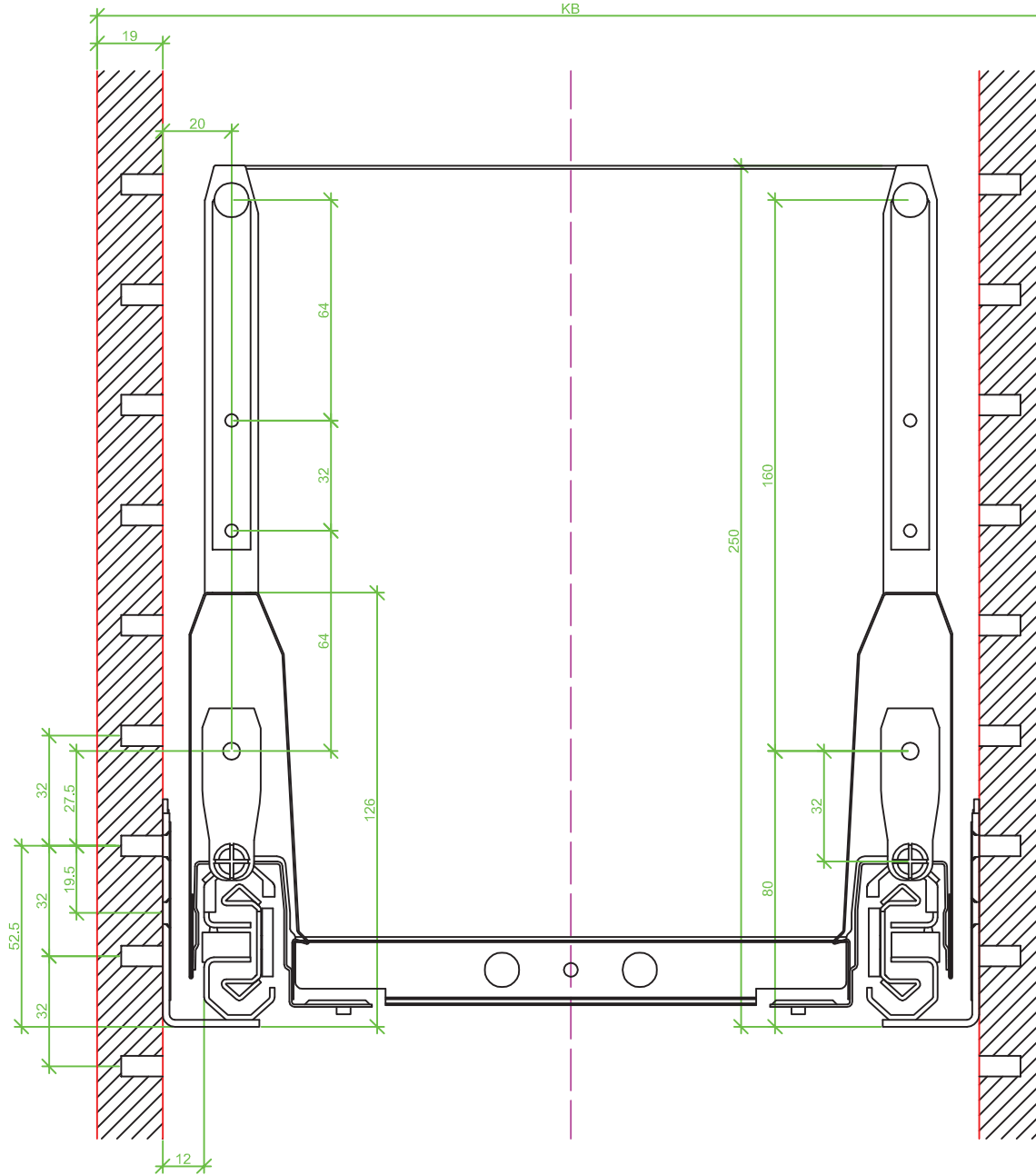



# Sideview / Seitenansicht (Railing / Reling)

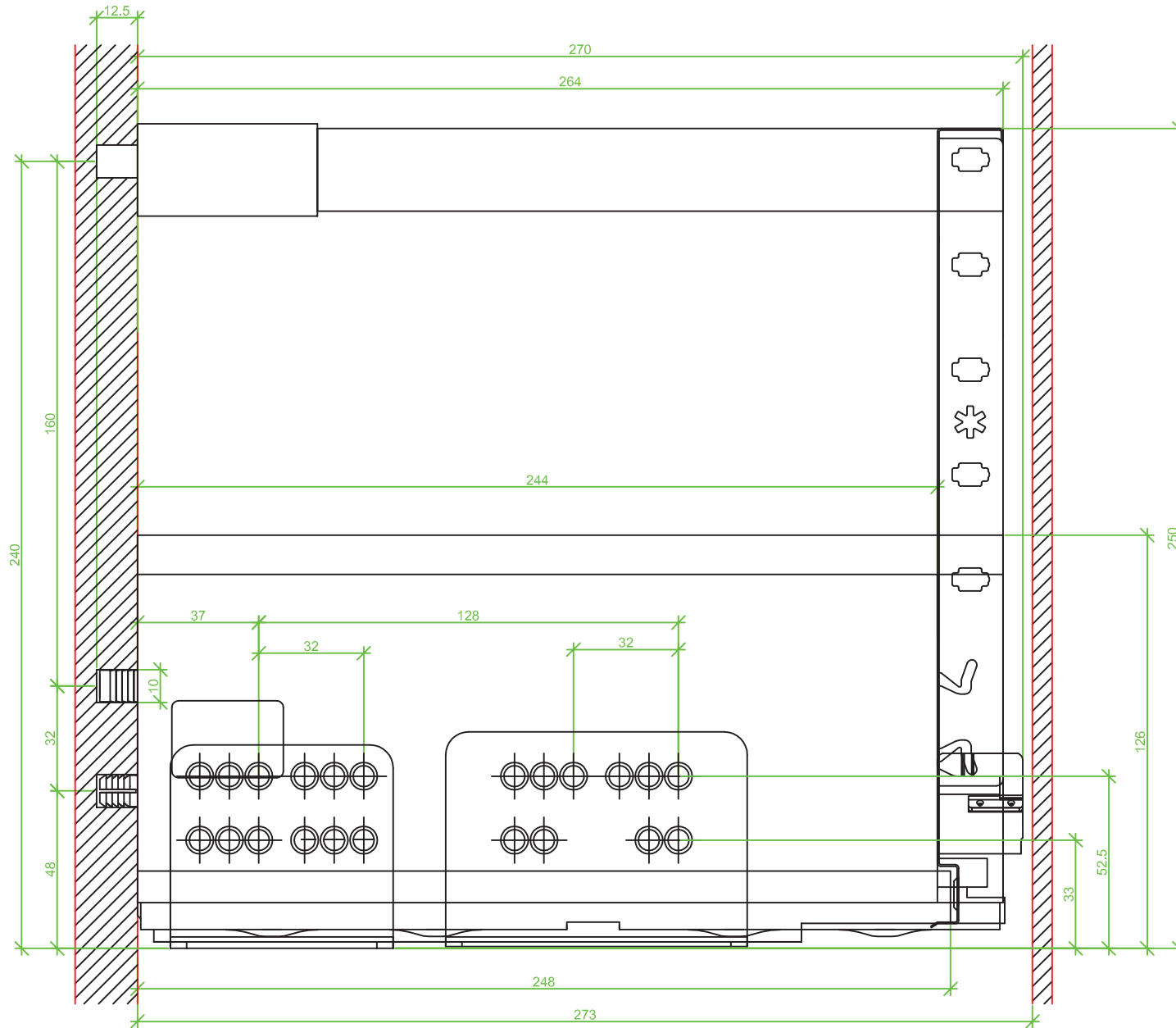

# Sideview / Seitenansicht (DesignSide / TopSide)

