

Drawings / Zeichnungen:
InnoTech Atira

Technik für Möbel

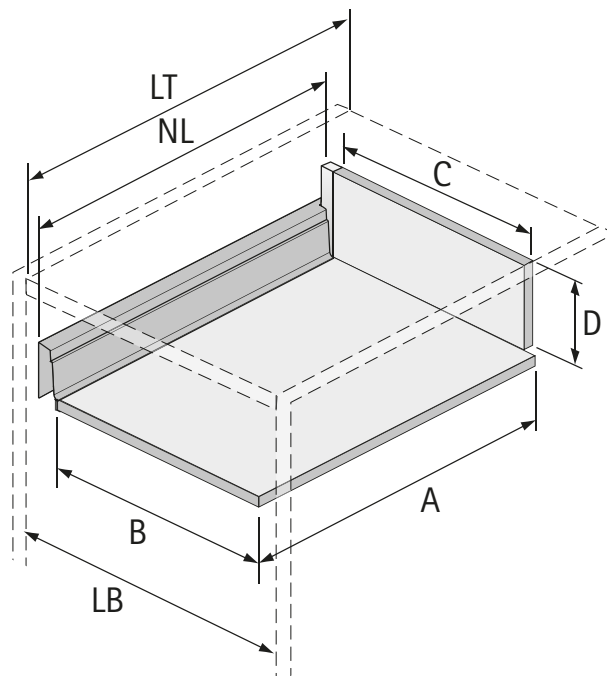

Model / Ausführung	Pot and pan drawer / Frontauszug
Height / Höhe	144
Profile height / Zargenhöhe	70 mm
Nominal length / Nennlänge	470
Cabinet side panel thickness / Korpuseitendicke	16 / 18 / 19 mm



Measurement / Maß	Steel rear panel / Stahlrückwand	Wooden rear panel / Holzrückwand	Aluminium rear panel / Aluminiumrückwand
A	467	480	467
B	$LB - 2x EB - 51,5$	$LB - 2x EB - 51,5$	$LB - 2x EB - 51,5$
C	-	$LB - 2x EB - 63$	$LB - 2x EB - 63$
D	-	144	-

Note: For Push to open applications NL 470 the minimum cabinet depth increases by 26 mm.

Achtung: Bei der Verwendung von Push to open NL 470 erhöht sich die Mindestkorpustiefe um 26 mm.

Frontview / Frontansicht 16 mm (Railing / Reling) Quadro 25

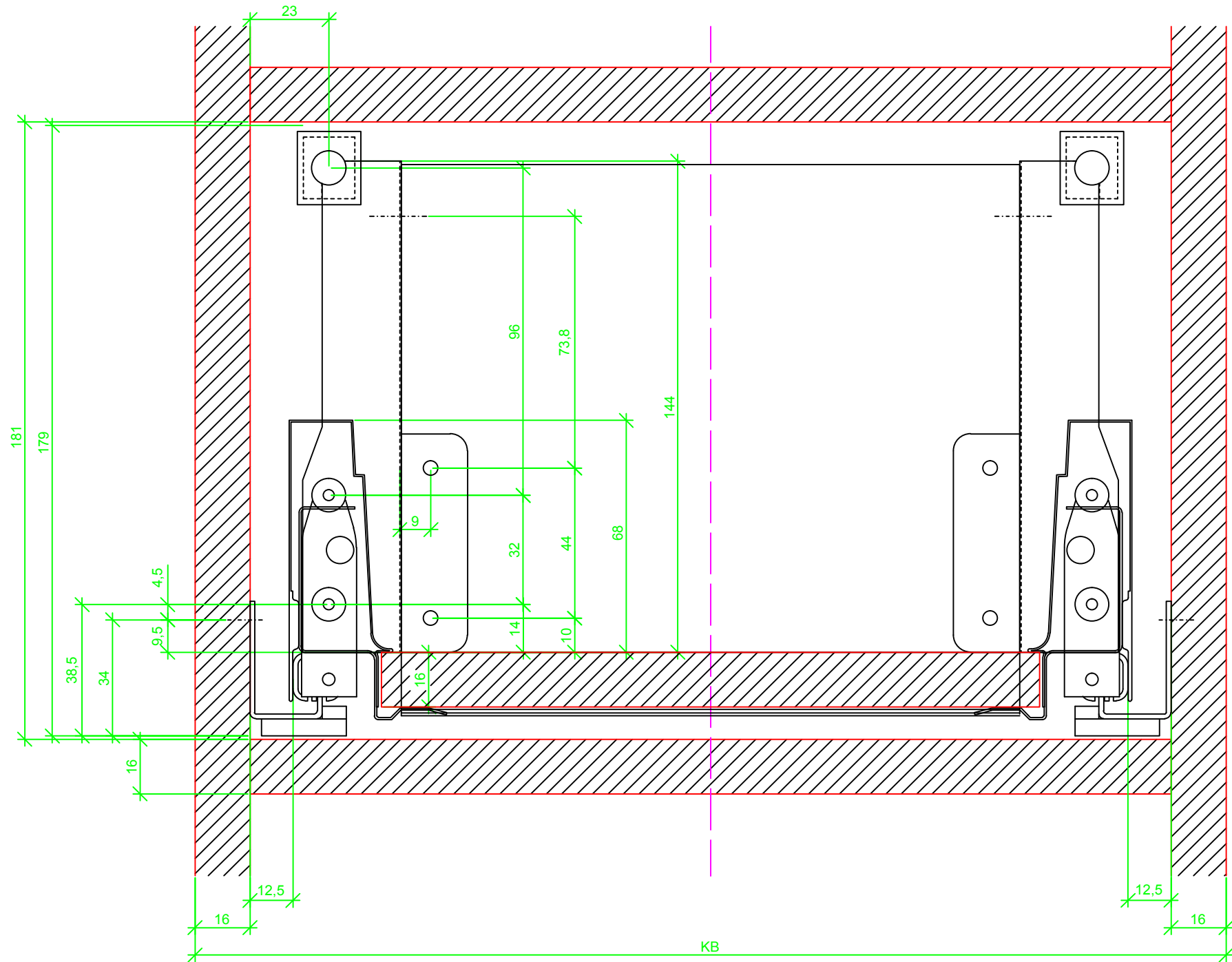

Frontview / Frontansicht 16 mm (DesignSide) Quadro V6+

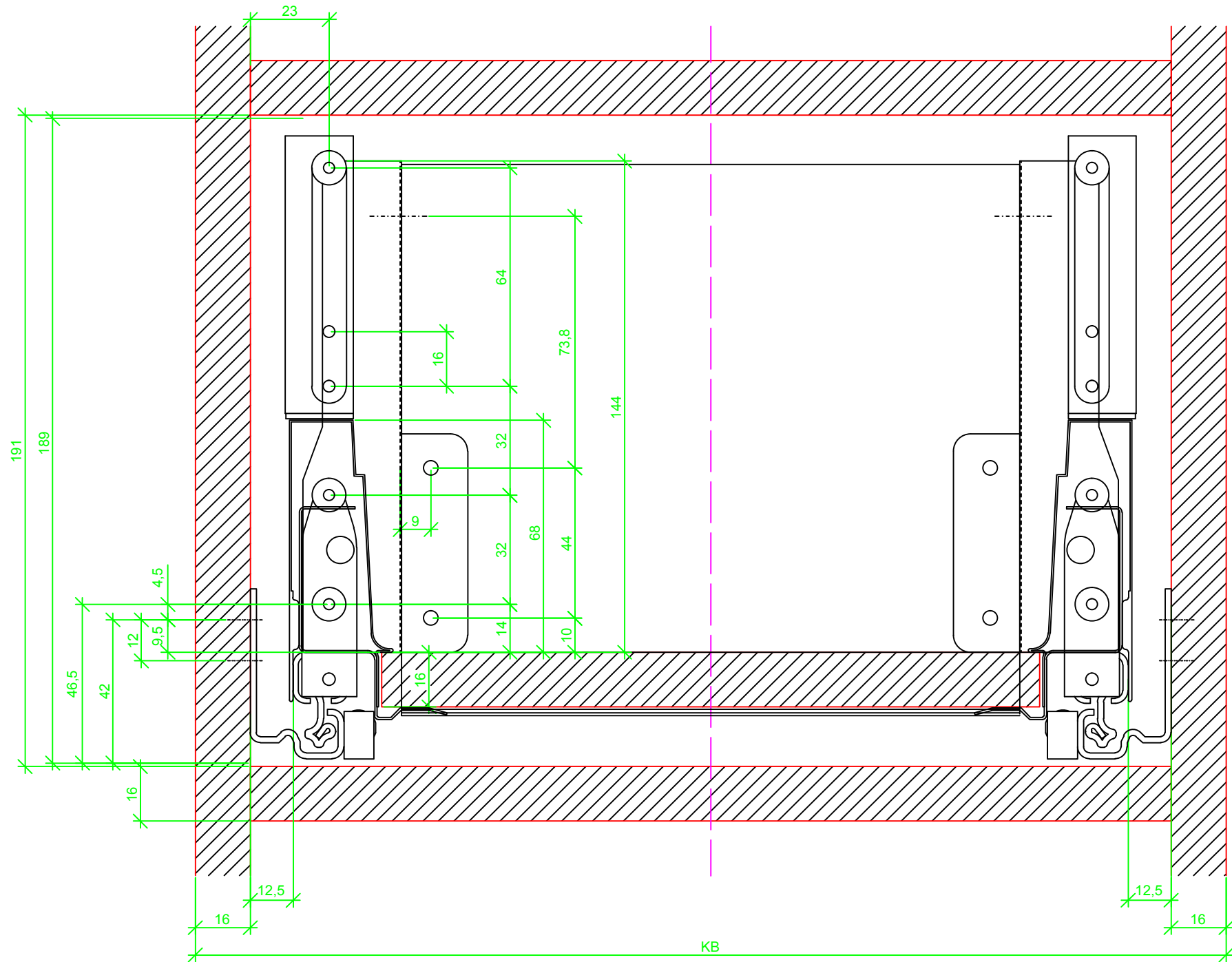

Frontview / Frontansicht 18 mm (Railing / Reling) Quadro V6

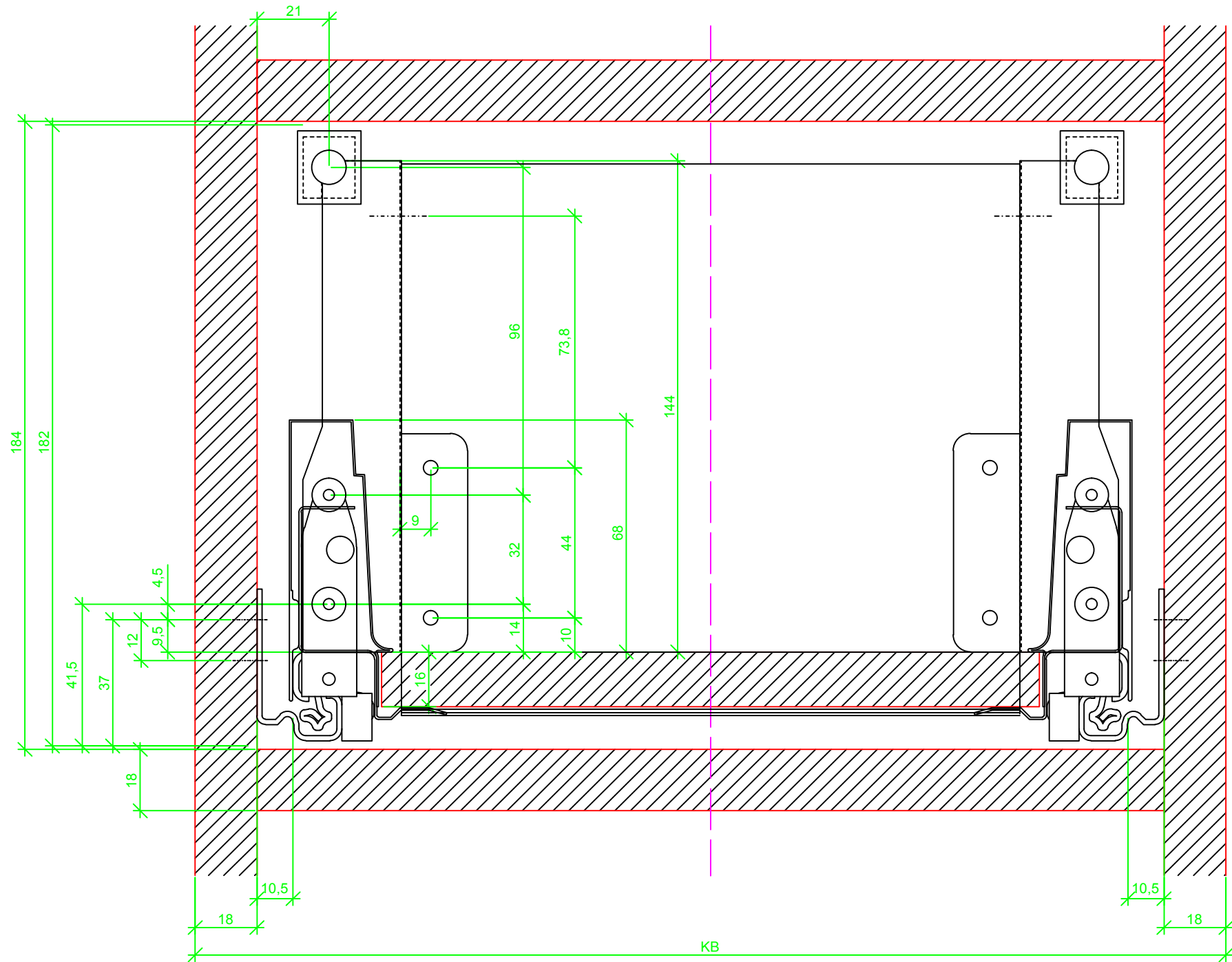

Frontview / Frontansicht 19 mm (DesignSide) Quadro 25

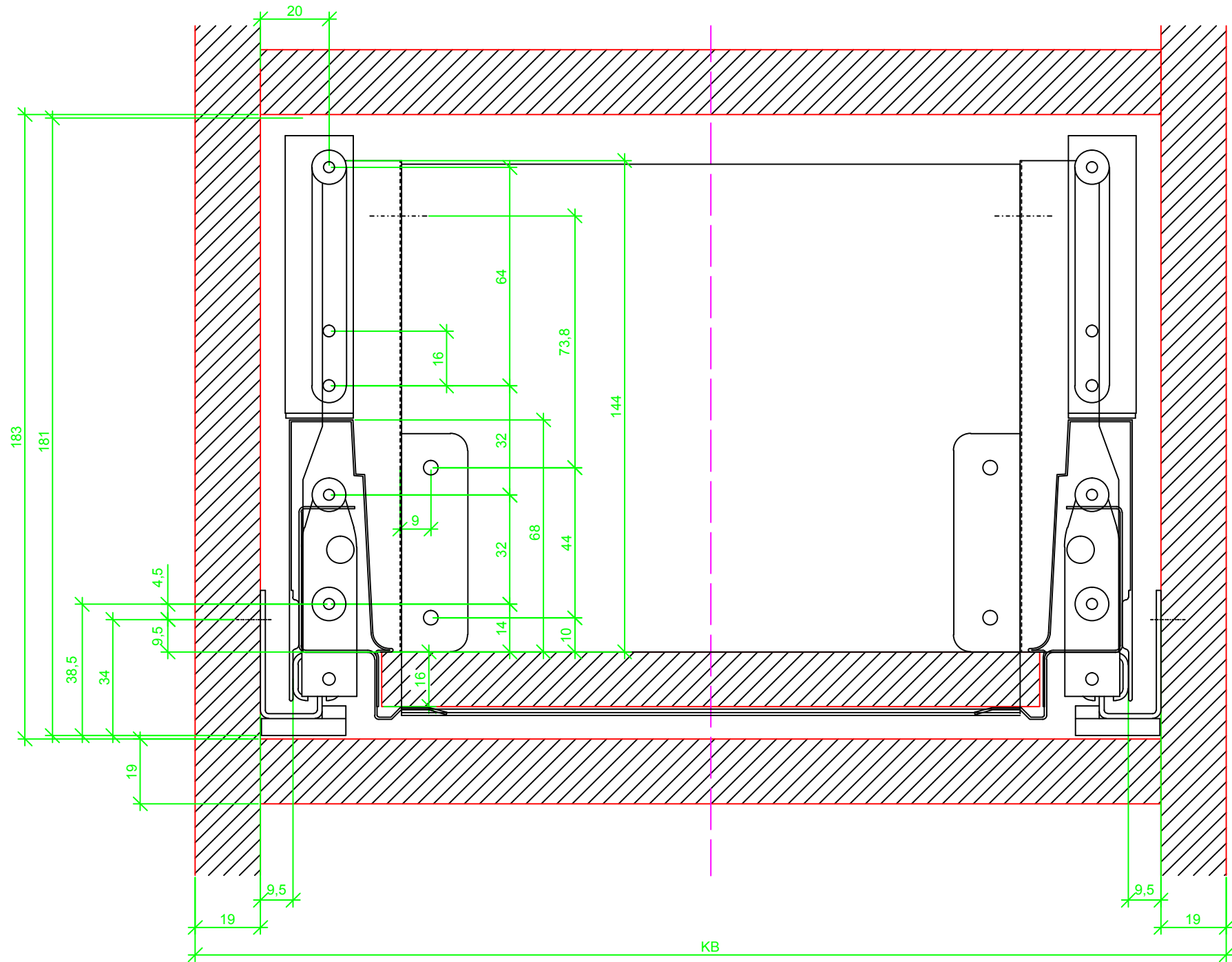

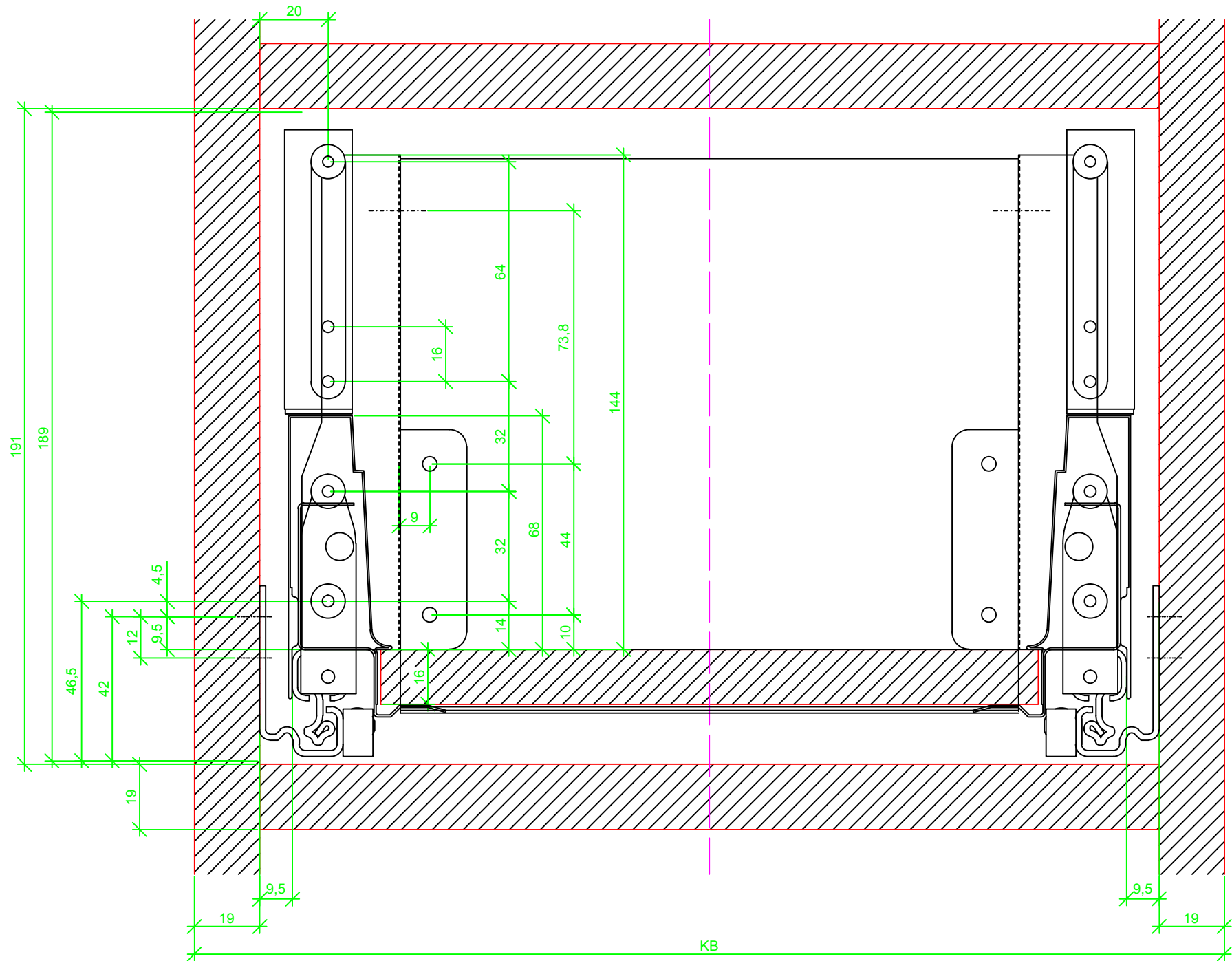

Sideview / Seitenansicht (Railing / Reling) Quadro 25

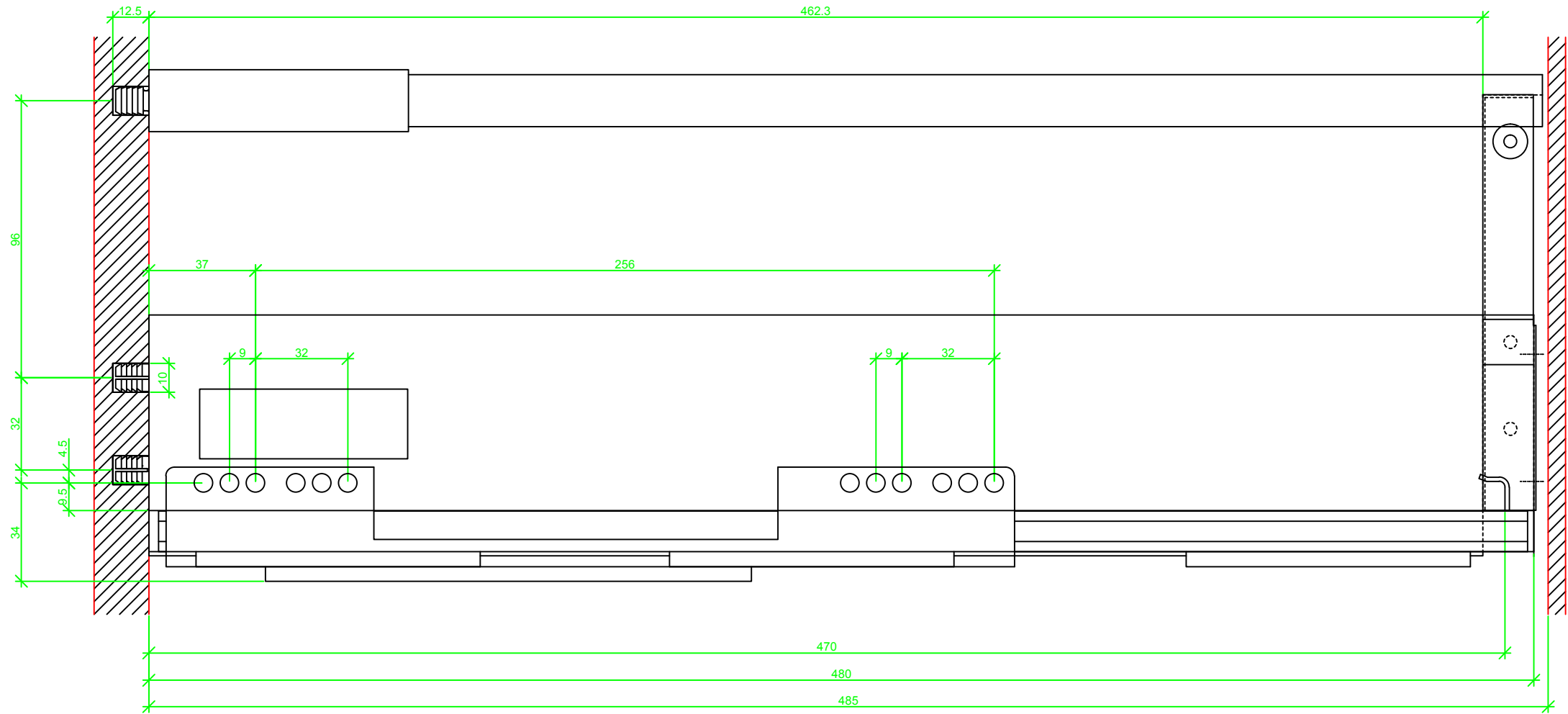

Sideview / Seitenansicht (Railing / Reling) Quadro V6

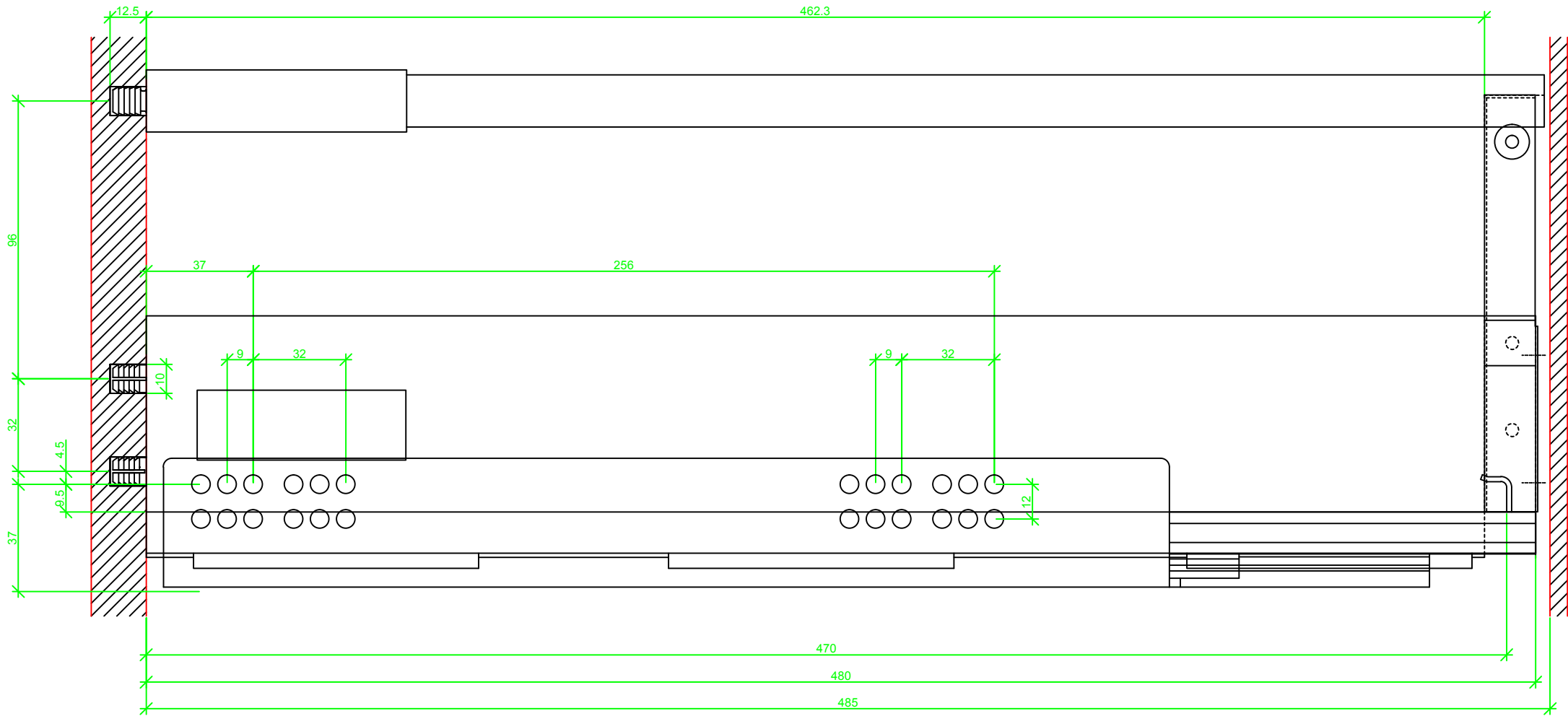

Sideview / Seitenansicht (Railing / Reling) Quadro V6+

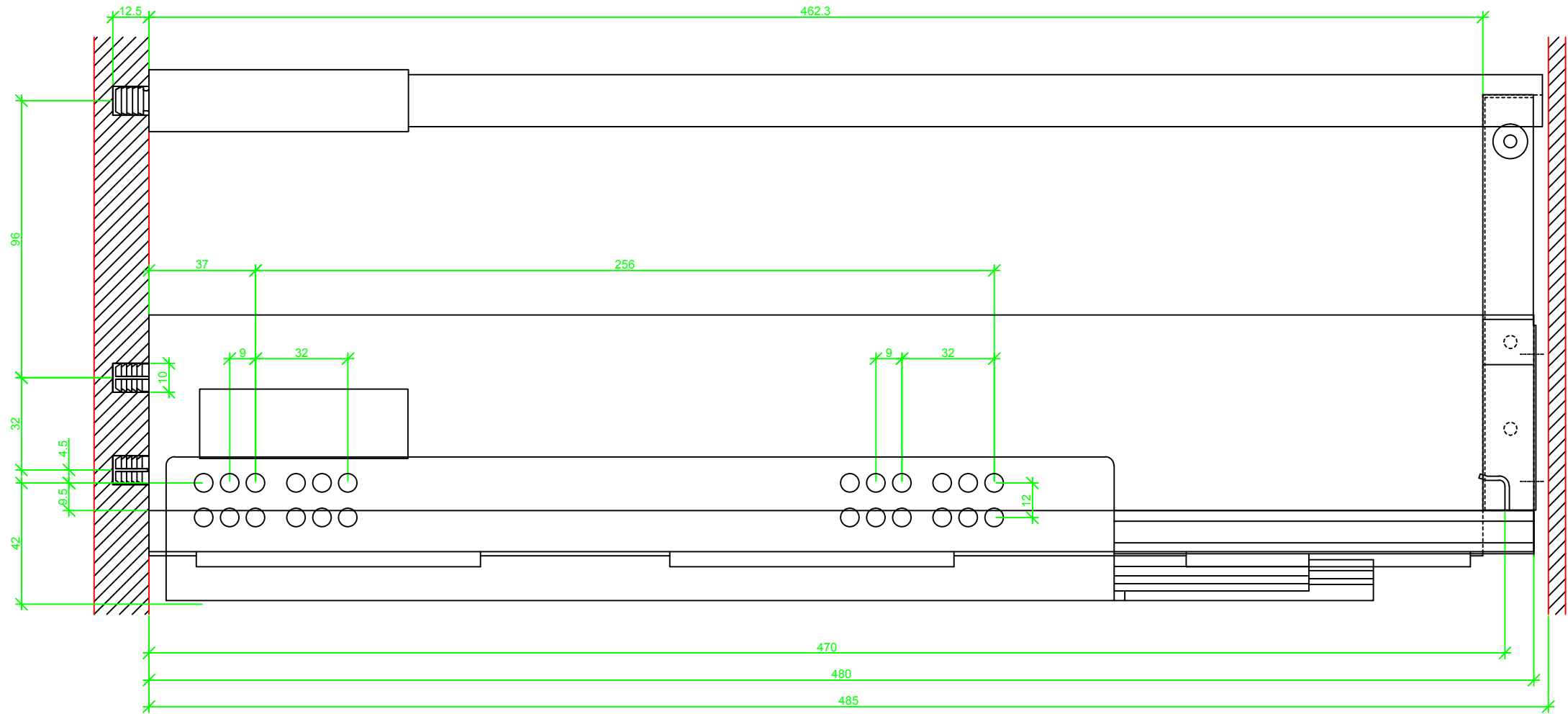

Sideview / Seitenansicht (DesignSide) Quadro V6

